	ITTC – Recommended Procedures and guidelines	7.6-02 -05 Page 1 of 15	
	Calibration of Dial Gauges	Effective Date 2002	Revision 00

ITTC Quality System Manual

Sample Work Instructions

Work Instructions

Calibration of Dial Gauges

7.6	Control of Inspection, Measuring and Test Equipment
7.6-02	Sample Work Instructions
7.6-02-05	Calibration of Dial Gauges

Disclaimer

All the information in ITTC Recommended Procedures and Guidelines is published in good faith. Neither ITTC nor committee members provide any warranties about the completeness, reliability, accuracy or otherwise of this information. Given the technical evolution, the ITTC Recommended Procedures and Guidelines are checked regularly by the relevant committee and updated when necessary. It is therefore important to always use the latest version.

Any action you take upon the information you find in the ITTC Recommended Procedures and Guidelines is strictly at your own responsibility. Neither ITTC nor committee members shall be liable for any losses and/or damages whatsoever in connection with the use of information available in the ITTC Recommended Procedures and Guidelines.

Updated / Edited by	Approved
Quality Systems Group of the 28 th ITTC	23 rd ITTC 2002
Date: 07/2017	Date: 09/2002



	ITTC – Recommended Procedures and guidelines	7.6-02 -05 Page 2 of 15	
	Calibration of Dial Gauges	Effective Date 2002	Revision 00

Table of Contents

<p>1. PURPOSE 4</p> <p>2. INTRODUCTION 4</p> <p>3. ITEM AND CONDITION OF CALIBRATION..... 4</p> <p style="padding-left: 20px;">3.1 Items and Main Tools of Calibration 4</p> <p style="padding-left: 20px;">3.2 Calibration Conditions 4</p> <p>4. TECHNICAL REQUIREMENTS AND CALIBRATION METHOD 5</p> <p style="padding-left: 20px;">4.1 Exterior..... 5</p> <p style="padding-left: 40px;">1.1.1 Requirements: 5</p> <p style="padding-left: 40px;">4.1.1 Calibration method..... 6</p> <p style="padding-left: 20px;">4.2 Relationship Among Parts 6</p> <p style="padding-left: 40px;">4.2.1 Requirements 6</p> <p style="padding-left: 40px;">4.2.2 Calibration Method: 6</p> <p style="padding-left: 20px;">4.3 Relative positions of point hand and dial plate..... 6</p> <p style="padding-left: 40px;">4.3.1 Requirements 6</p> <p style="padding-left: 40px;">4.3.2 Calibration Method 7</p> <p style="padding-left: 20px;">4.4 Width of Indicator Needle End and Dial Plate Lines 7</p> <p style="padding-left: 40px;">4.4.1 Requirements: 7</p> <p style="padding-left: 40px;">4.4.2 Calibration method..... 7</p> <p style="padding-left: 20px;">4.5 Roughness of Measuring Head Working Surface..... 8</p> <p style="padding-left: 40px;">4.5.1 Requirements: 8</p> <p style="padding-left: 40px;">4.5.2 Calibration Method: 8</p>	<p>4.6 Diameter of clamping sleeve 8</p> <p style="padding-left: 20px;">4.6.1 Requirements 8</p> <p style="padding-left: 20px;">4.6.2 Calibration Method: 8</p> <p>4.7 Measuring force..... 8</p> <p style="padding-left: 20px;">4.7.1 Requirements 8</p> <p style="padding-left: 20px;">4.7.2 Calibration Methods:..... 8</p> <p>4.8 Hysteresis of Indication..... 9</p> <p style="padding-left: 20px;">4.8.1 Requirements 9</p> <p style="padding-left: 20px;">4.8.2 Calibration Method: 9</p> <p>4.9 Effect on indication from radial force of survey rod..... 10</p> <p style="padding-left: 20px;">4.9.1 Requirements: 10</p> <p style="padding-left: 20px;">4.9.2 Calibration Method: 10</p> <p>4.10 Error of indication 10</p> <p style="padding-left: 20px;">4.10.1 Requirements: 10</p> <p style="padding-left: 20px;">4.10.2 Calibration Method 10</p> <p>4.11 Error of Return 12</p> <p style="padding-left: 20px;">4.11.1 Requirements: 12</p> <p style="padding-left: 20px;">4.11.2 Calibration methods: 12</p> <p>5. TREATMENT OF CALIBRATION RESULT AND CALIBRATION PERIOD 13</p> <p style="padding-left: 20px;">5.1 Treatment of Calibration Result ... 13</p> <p style="padding-left: 40px;">5.1.1 Calibration Period 13</p> <p>APPENDIX A..... 14</p> <p style="padding-left: 20px;">A.1. Calibration method for additional points 14</p>
---	---

	ITTC – Recommended Procedures and guidelines	7.6-02 -05 Page 3 of 15	
	Calibration of Dial Gauges	Effective Date 2002	Revision 00

Source

Verification regulation of dial gauge (reading in 0.01 mm and 0.001 mm)

[Issued on Feb. 14, 1996 and put into effect since June 1, 1996 by National Technical Bureau - **JJG 34—96, National Measuring Verification Regulation of People’s Republic of China**]

	ITTC – Recommended Procedures and guidelines	7.6-02 -05 Page 4 of 15	
	Calibration of Dial Gauges	Effective Date 2002	Revision 00

Calibration of Dial Gauges

1. PURPOSE

This working instruction can be applied to the verification of new dial gauges or to the calibration of dial gauges in service and after repair, having a scale division of 0.01 mm, measuring ranges 0~3, 0~5, 0~10 mm and with a scale division of 0.001 mm and measuring ranges between 0~1, 0~2, 0~3, 0~5mm.

2. INTRODUCTION

Dial gauge is a metrological tool which uses the rack gear or the level gear operation to transfer the line displacement of the survey rod into an angular one of the pointer hand. Its main usage is to measure the size, the shape and the position error of products. The outlines of the dial gauges are shown in Figure 1 (reading in 0.01mm) and in Figure 2 (reading in 0.001mm).

3. ITEM AND CONDITION OF CALIBRATION

3.1 Items and Main Tools of Calibration

The items and the main tools of the calibration for dial gauges are listed in Table 1.

3.2 Calibration Conditions

Before the calibration the dial gauge must be kept in the room for temperature equilibrium

and by the time of the calibration the room temperature must meet the requirements in Table 2.

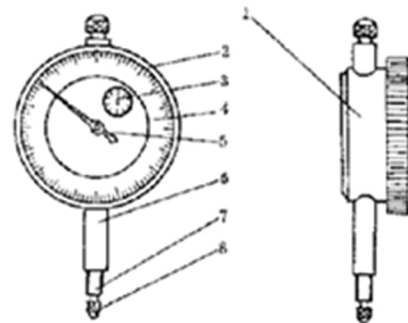

Fig. 1 Dial gauge (with the reading in 0.01mm). 1 dial gauge body; 2 dial gauge ring; 3 revolution point hand; 4 dial plate; 5 point hand (needle); 6 clamping sleeve; 7 survey rod; 8 measuring head.

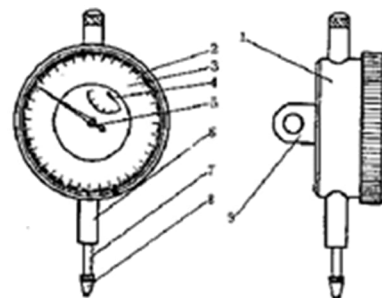

Fig.2 Dial gauge (with the reading in 0.001mm). 1 dial gauge body; 2 dial gauge ring; 3 dial plate; 4 revolution point hand; 5 point hand; 6 clamping sleeve; 7 survey rod; 8 measuring head; 9 ear ring.

 ITTC INTERNATIONAL TOWING TANK CONFERENCE	ITTC – Recommended Procedures and guidelines	7.6-02 -05 Page 5 of 15	
	Calibration of Dial Gauges	Effective Date 2002	Revision 00

Table 1

No	Item	Main calibration tools	Type of calibration		
			New product	In service	After repair
1	Exterior	-----	+	+	+
2	Relationship among parts	Raster calibration instrument for dial gauge or dial gauge calibrator	+	+	+
3	Relative positions of pointer hand and dial plate	Tool microscope	+	+	+
4	Width of pointer hand end and dial plate lines	Tool microscope	+	-	+
5	Roughness of measuring head working surface	Sample block for comparison of surface roughness or measuring apparatus of surface roughness	+	-	+
6	Diameter of clamping sleeve	First class	+	-	+
7	Measuring force	Force gauge	+	+	+
8	Hysteresis of indication	Rigid mounting for dial gauge, leveling working platform	+	+	+
9	Effect on indication from radial force of survey rod	Half cylinder side block, rigid mounting for dial gauge, working platform with reinforcement	+	+	+
10	Error of indication	Raster calibration instrument for dial gauge or dial gauge calibrator	+	+	+
11	Error of return		+	+	+

Note: “+” means calibration must be done; “-“ means calibration may not be done

Table 2

4. TECHNICAL REQUIREMENTS AND CALIBRATION METHOD

4.1 Exterior

1.1.1 Requirements:

The watch glass of the dial gauge should be transparent and clear without any air bubbles and obvious scores.

Room temperature	Temperature Change per hour	Time for Temperature balance
20±10 °C	≠ 1°C	≥ 2h

The lines of the dial plate should appear clear and straight to the eye, without any breaks and uneven thickness. The measuring head should not have any mechanical damage, rust spots or obvious scoring. There should be no paint drops,

	ITTC – Recommended Procedures and guidelines	7.6-02 -05 Page 6 of 15	
	Calibration of Dial Gauges	Effective Date 2002	Revision 00

poor chromium plating, burrs or any other fault which affects the exterior quality.

The name of the manufacturer or the trademark, the scale division value and the production serial number should be marked on the dial gauge.

A dial gauge in service and after repair should not have an exterior fault which affects its accuracy.

4.1.1 Calibration method

By eyesight.

4.2 Relationship Among Parts

4.2.1 Requirements

The dial gauge ring should be steadily movable. Its stopping should be reliable. The clearance between ring and body should not have obvious looseness .

The movement of the survey rod and the return of the needle should be steady and nimble without any phenomena like jumping, seizure, and retarded motion.

The pointer hand should be tightly fixed on the shaft. It should not be loose when the survey rod is moved.

The survey rod should be freely movable and must not be seized after the clamping sleeve has been positioned and fastened on the dial gauge.

4.2.2 Calibration Method:

Testing and observation.

4.3 Relative positions of point hand and dial plate

4.3.1 Requirements

The zero line of the dial plate should be adjusted till it coincidences with the shaft direction of the survey rod, when the survey rod of the dial gauge locates at the free position. This position of the needle should meet the requirement in Table 3

Table 3 (scale division)

Scale mark type of dial plate	Pointer hand locates on upper-left of zero scale mark
50	4~12
100	8~25
200	16~50

Table 4

Type	Measuring range (mm)	Scale mark type of dial plate (scale division)	Running distance beyond end point (mm)
Reading in 0.01mm	0~3	50	≥ 0.30
	0~5, 0~10	100	≥ 0.50
Reading in 0.001mm	0~1,	100	≥ 0.05
	0~2,	200	≥ 0.10
	0~3 0~5		

The survey rod running distance of the dial gauge should exceed the end point of the working running distance. The exceeding running distance should meet the requirement written in Table 4.

	ITTC – Recommended Procedures and guidelines	7.6-02 -05 Page 7 of 15	
	Calibration of Dial Gauges	Effective Date 2002	Revision 00

When the revolving needle points to any of the integral revolutions the position of the needle should meet the requirements in Table 5.

Table 5 (scale division)

Type	Point hand deviation from the zero position
Reading in 0.01mm	≤ 15
Reading in 0.001mm	≤ 20

The direction of the needle end should be the same as the one of the dial plate line, without any deflection seen by eyesight. The distance between the upper surface of the needle end and the dial plate shouldn't exceed the values in Table 6.

The end of the needle should cover 30~80% length of the short scale mark.

4.3.2 Calibration Method

The distance between the upper surface of the needle end and the dial plate can be observed by eyesight. If there is any dispute, it can be calibrated by use of a tool microscope with the lens at five-times magnification. The lens can be focused on the upper surface of the needle and the dial plate respectively, the values can be obtained by reading with the final motion device or can be read through an additional dial gauge with an accuracy of 0.01mm. The difference of

these two readings is the distance between the upper surface of the needle end and the plane of the dial plate.

Table 6

Type	Scale mark type of dial plate (scale division)	Distance between pointer hand end upper surface and dial plate
Reading in 0.01mm	50, 100	0.9mm
Reading in 0.001mm	100	0.9mm
	200	0.7mm

4.4 Width of Indicator Needle End and Dial Plate Lines

4.4.1 Requirements:

The values in Table 7 should not be exceeded.

4.4.2 Calibration method

The calibration can be made by use of a tool microscope. At least three lines should be selectively calibrated.

 INTERNATIONAL TOWING TANK CONFERENCE	ITTC – Recommended Procedures and guidelines	7.6-02 -05 Page 8 of 15	
	Calibration of Dial Gauges	Effective Date 2002	Revision 00

Table 7

Type	Measured range (mm)	Scale mark type of dial plate (scale division)	Diameter of dial gauge ring	Width of pointer hand end and dial plate lines (mm)
Reading in 0.01mm	0~3	50	42mm	0.10~0.20
	0~5, 0~10	100	>42mm	0.15~0.25
Reading in 0.001mm	0~1, 0~2, 0~3, 0~5	100	42mm	0.10~0.20
			>42mm	0.15~0.25
		200	>42mm	0.10~0.20

4.5 Roughness of Measuring Head Working Surface

4.5.1 Requirements:

The values in Table 8 should not be exceeded.

Table 8 (μm)

Material of measuring head	Steel	Hard alloy	Gem
Roughness of measuring head working surface	R_a 0.1	R_a 0.2	R_a 0.05

4.5.2 Calibration Method:

It may be calibrated using the comparing method with a sample block for the comparison of the surface roughness. If there is any dispute, a measuring apparatus of surface roughness can be used for calibration.

4.6 Diameter of clamping sleeve

4.6.1 Requirements

The diameter should be $\phi 8_{-0.015}^{+0}$ mm.

4.6.2 Calibration Method:

The calibration of the clamping sleeve diameter can be made by use of a first class dial gauge.

4.7 Measuring force

4.7.1 Requirements

The measuring force should not exceed the values in Table 9.

4.7.2 Calibration Methods:

The calibration should be carried out at three positions, the beginning, the mid and the end position of the working running distance for the dial gauge using a force gauge with the scale division not bigger than 0.1 N. After the forward direction calibration is over, let the needle continue going for 5~10 scale divisions, then the return direction calibration can be carried out.

 INTERNATIONAL TOWING TANK CONFERENCE	ITTC – Recommended Procedures and guidelines	7.6-02 -05 Page 9 of 15	
	Calibration of Dial Gauges	Effective Date 2002	Revision 00

The maximum force measured in the forward running direction is taken as the maximum measured force of the dial gauge. The difference of the maximum and the minimum forces measured in one direction are taken as the change of the measured force in one direction. The difference between the measured forces in the forward and the return direction, at the calibration

points, can be taken as the change of the measured force in forward and return directions at the same point. All of these should not exceed the values in Table 9.

Table 9 (N)

Type	Measured range (mm)	Maximum measured force	Change of measured force in one direction running distance	Change of measured force in go and return direction at same point
Reading in 0.01mm	0~3, 0~5, 0~10	1.5	0.5	0.4
Reading in 0.001mm	0~1, 0~2	1.5	0.4	0.4
	0~3, 0~5	1.5	0.5	0.5

Table 10 (μm)

Type	Measurement range (mm)	Indication hysteresis		Effect on indication from radial force of survey rod	
		Zero class	First class	Zero class	First class
Reading in 0.01mm	0~3, 0~5, 0~10	3	5	3	5
Reading in 0.001mm	0~1, 0~2, 0~3	0.3	0.5	0.3	0.5
	0~5	0.4	0.5	0.4	0.5

4.8 Hysteresis of Indication

4.8.1 Requirements

The hysteresis of indication for the dial gauge should not exceed the values in Table 10.

4.8.2 Calibration Method:

The dial gauge should be clamped on a rigid mounting to make the shaft line of the survey rod vertical to the levelling plane. The survey

rod must be lifted five times when the needle has been adjusted until it points to the scale mark at the beginning, the mid and the end positions of the range respectively. The difference between the maximum and the minimum values of five readings each are taken as the indication hysteresis of the relevant point. The indication hysteresis at the above mentioned three positions should not exceed the values in Table 10.

	ITTC – Recommended Procedures and guidelines	7.6-02 -05 Page 10 of 15	
	Calibration of Dial Gauges	Effective Date 2002	Revision 00

4.9 Effect on indication from radial force of survey rod

4.9.1 Requirements:

The values in Table 10 shouldn't be exceeded.

4.9.2 Calibration Method:

The dial gauge should be clamped on a rigid mounting to make the shaft line of the survey rod vertical to the working platform with reinforcement. One piece of the half cylinder side block with a radius of 10 mm (appendage of the measuring block) should be positioned between the measuring head and the working platform. The dial gauge at the zero position of the working range should be adjusted till the point near the maximum position of the side block cylinder surface is touched. The side block should be moved twice for each of four positions, the front, the back, the left and the right of the gauge along the direction vertical to the generating line of the side block respectively. The maximum value (the turning point) should be read each time when the measuring head touches the maximum point of the side block. The difference of the maximum and the minimum among eight readings should not exceed the values in Table 10. Such a calibration should be performed at the middle and the end positions of the measurement range.

4.10 Error of indication

4.10.1 Requirements:

The indication errors of 0.01 and 0.001mm reading dial gauges should not exceed the values in Tables 11 and 12 respectively.

4.10.2 Calibration Method

Dial gauges with in 0.01 mm readings can be calibrated by use of a raster calibration instrument for dial gauges or a calibrator for dial gauges with 0.01mm readings. Dial gauges with 0.001 mm readings can be calibrated by use of a raster calibration instrument for dial gauges or a calibrator dial gauges with 0.001 mm readings. Other methods can be used for the calibration, the accuracy of which should not be lower.

The zero positioning of the calibration instrument (or the calibrator) and of the dial gauge should be adjusted at the beginning of the calibration. The indication error of the dial gauge with a 0.01 mm reading should be calibrated at the points of every 10-scale division interval in the direction of the forward and the return travel. The indication error of dial gauges with a 0.001 mm reading should be calibrated at the points of every 50-scale division interval in the direction of the forward and the return travel. The relevant error of every point can be read from the dial gauge after the needle has been shifted to the scale divisions of the instrument, till the end of the working running distance. Then the survey rod can be compressed for the needle turning 10-scale division and the calibration can be carried out in the return direction.

 INTERNATIONAL TOWING TANK CONFERENCE	ITTC – Recommended Procedures and guidelines	7.6-02 -05 Page 11 of 15	
	Calibration of Dial Gauges	Effective Date 2002	Revision 00

During the whole calibration process the direction of travel of the survey rod must not be changed right in the middle and any adjustment must not be done on the calibrated dial gauge and on the calibrating instrument (or the calibra-

tor). Whether the error in the return travels positive or negative can be determined in the same way as that for the forward travel running distance.

Table 11

Accuracy class	Indication error of 0.01mm reading dial gauge (μm)					Return error (μm)
	Optional 0.1mm	Optional 1mm	Working running distance			
			0~3mm	0~5mm	0~10mm	
0	5	8	10	12	14	3
1	7	10	15	18	20	5

Table 12

Measured range (mm)	Indication error of 0.001mm reading dial gauge (μm)				Return error (μm)	
	Optional 0.2mm		Working running distance		Zero class	First class
	Zero class	First class	Zero class	First class		
0~1	3.0	3.5	4	5	2.0	2.5
0~2	3.0	3.5	5	6	2.0	2.5
0~3	3.5	4.0	7	8	2.5	3.0
0~5	3.5	4.0	8	9	2.5	3.0

The indication error of the measuring range of the dial gauge can be determined from the difference of the maximum and the minimum values of the errors at each calibrated point within the measuring range.

The indication error of a dial gauge with a reading in 0.01 mm at the condition of optional 1 mm can be determined from the difference between the maximum and the minimum of the errors measured in each section of the forward travel 0~1, 1~2, 2~3, 3~4, mm.

The indication error of a dial gauge with 0.001 mm readings at the condition of op-

tional 0.2 mm can be determined from the difference between the maximum and the minimum of the errors measured in each section of the direction of forward travel 0~0.2, 0.2~0.4, 0.4~0.6, mm.

The indication error of the dial gauge with 0.01 mm readings within the range of optional 0.1 mm can be determined from the difference of the errors measured at two optional adjacent points in the direction of forward travel.

The calibration of the indication error for an in service dial gauge with 0.01 mm readings by use of the 0.01 mm reading dial gauge calibrator can be carried out on the basis of 20-scale division interval. After this calibration is over, if the

 INTERNATIONAL TOWING TANK CONFERENCE	ITTC – Recommended Procedures and guidelines	7.6-02 -05 Page 12 of 15	
	Calibration of Dial Gauges	Effective Date 2002	Revision 00

indication errors of the working running distance and the optional 1mm are close to the values in Table 11 and the indication error of the adjacent points exceeds the values of the optional 0.1mm indication error in Table 11, calibration of additional points should be carried out. This method is shown in the Appendix.

4.11 Error of Return

4.11.1 Requirements:

The return error of the dial gauge should not exceed the values given in Tables 11 and 12.

4.11.2 Calibration methods:

After the calibration of the indication error, the maximum of the differences of the errors between the forward and the return directions of travel can be taken as return error at the same point.

Table 13 shows the data treatment of the indication and the return errors of the dial gauge with the reading in 0.01 mm.

Table 13

Distance of travel(mm)		Calibrated point (scale division)										
		0	10	20	30	40	50	60	70	80	90	0
		Error (µm)										
0~1	Forward	0	0	0	+4	+6	+2	+2	0	0	+1	+1
	Return	+1	+2	+1	+5	+5	+4	+4	+1	0	+1	+1
1~2	Forward	+1	0	+1	+2	+3	+6	+5	+4	+2	+2	-1
	Return	+1	+1	+3	+4	+5	+6	+6	+3	+3	+1	+2
2~3	Forward	-1	+4	+2	+4	+8	+8	(+10)	+8	+8	+6	+6
	Return	+2	+4	+3	+4	+8	+9	+11	+8	+7	+7	+6
3~4	Forward	+6	+2	-1	-1	0	0	-1	0	-1	-1	-2
	Return	+6	+1	+1	0	+1	0	+2	0	+1	0	-2
4~5	Forward	-2	(-3)	-3	-3	-1	-1	-2	-2	-1	-2	-1
	Return	-2	-2	-2	-2	-1	-1	-2	0	0	0	0

The indication error of the measuring range:
10-(-3)=13µm

The return error: 2-(-1)=3µm

The indication error within the range of the optional 0.1mm: 4-(-1)=5µm

The indication error within the range of the optional 1mm: the indication error within the range of 2~3 mm is at maximum. 10-(-1)=11µm

	ITTC – Recommended Procedures and guidelines	7.6-02 -05 Page 13 of 15	
	Calibration of Dial Gauges	Effective Date 2002	Revision 00

5. TREATMENT OF CALIBRATION RESULT AND CALIBRATION PERIOD

5.1 Treatment of Calibration Result

For the dial gauges that meet the requirements of this working instruction during calibration, a calibration report will be supplied;

For the ones which do not meet the requirements a notice of the calibration result will be supplied.

5.1.1 Calibration Period

The calibration period can be determined upon the service condition, but not longer than one-year.

	ITTC – Recommended Procedures and guidelines	7.6-02 -05 Page 14 of 15	
	Calibration of Dial Gauges	Effective Date 2002	Revision 00

Appendix A.

A.1. Calibration method for additional points

1. Usage range: The calibration of the indication error and the return error for the dial gauge with the reading in 0.01mm in service.
2. Equipment for calibration: Calibrator for dial gauges.
3. Technical requirements: The values in Table 11 should not be exceeded.
4. Calibration method: The calibration of the indication error for the dial gauge with the reading in 0.01 mm in service can be carried out on the basis of 20-scale division interval in the directions of the go and the return distance. After the calibration, if the indication errors of the measuring range and the optional 1 mm are close to values in Table 11, the calibration of the additional points in the area of the maximum, the minimum errors in the forward distance of travel and the maximum, the minimum errors of the optional 1 mm should be carried out respectively.

During the calibration of the additional points the clamping position of the calibrated dial gauge should be kept the same as before. The calibrator should be adjusted to the positions 0.1 mm before and after the point of the maximum error in the go running distance for the additional points calibration respectively. If there is an error in an additional point that is bigger than the original maximum, this error of the

additional point should be taken as maximum error.

Similarly, the calibration of the additional points should be carried out at the positions 0.1mm before and after the point of the minimum error in the forward distance of travel of the calibrated dial gauge. If there is an error in an additional point which is smaller than the original minimum, this error of the additional point should be taken as minimum error.

The same method should be used for the calibration of the additional points in the area of the maximum and the minimum errors for the optional 0.1 mm.

If the indication error of the adjacent points exceeds values of the indication error for the optional 0.1 mm in Table 11, a calibration of the middle point between these adjacent points should be carried out.

Table 14 shows the data treatment of the indication error and the return error for a dial gauge with the reading in 0.01 mm in service.

The indication error of the measuring range:
 $11 - (-9) = 20\mu\text{m}$

The indication error within the range of the optional 1mm: $11 - 0 = 11\mu\text{m}$

The indication error within the range of the optional 0.1 mm: $11 - 5 = 6\mu\text{m}$ (at the position 0.7~0.8mm of the first revolution)

The return error: $0 - (-4) = 4\mu\text{m}$.

 INTERNATIONAL TOWING TANK CONFERENCE	ITTC – Recommended Procedures and guidelines						7.6-02 -05 Page 15 of 15		
	Calibration of Dial Gauges						Effective Date 2002	Revision 00	

Table 14

Distance of travel (mm)		Calibrated point (scale division)						Optional 1mm	Optional 0.1mm	Whole distance error							
		0	20	40	60	80	0										
0~1	Go	0	+2	+3	(+8)	+5	+1	8	6	20							
	R ^①	+1	+3	+5	+9	+6	+3	(11)									
1~2	Go	+1	+3	+4	+6	+6	+7	6			6	Return error					
	R	+3	+5	+5	+6	+5	+8										
2~3	Go	+7	-1	+1	-1	-1	-1	8		6			4				
	R	+8	+2	+3	0	0	-1										
3~4	Go	-2	-4	-3	-3	-1	-3	3	6								
	R	-1	-1	-2	-3	0	-1										
4~5	Go	-3	(-9)	-4	-4	-3	-3	6			6						
	R	-1	-6	0	-3	0	-1										
Calibration of additional points								Maximum		Minimum		Optional 0.1mm					
Distance of travel (mm)								0~1		4~5		2~3					
Calibrated point (scale division)								50	60	70		10	20	30	0	10	20
Indication error (µm)								+5	+8	+11		-5	-9	-6	+7	+3	-1

Note: ① means the return distance of travel.