	<b>ITTC – Recommended Procedures and guidelines</b>	<b>7.6-02 -04</b> Page 1 of 14	
	<b>Calibration of Micrometres</b>	Effective Date 2002	Revision 00

## ITTC Quality System Manual

### Sample Work Instructions

#### Work Instructions

### Calibration of Micrometres

7.6	Control of Inspection, Measuring and Test Equipment
7.6-02	Sample Work Instructions
7.6-02-04	Calibration of Micrometres

#### Disclaimer

**All the information in ITTC Recommended Procedures and Guidelines is published in good faith. Neither ITTC nor committee members provide any warranties about the completeness, reliability, accuracy or otherwise of this information. Given the technical evolution, the ITTC Recommended Procedures and Guidelines are checked regularly by the relevant committee and updated when necessary. It is therefore important to always use the latest version.**

**Any action you take upon the information you find in the ITTC Recommended Procedures and Guidelines is strictly at your own responsibility. Neither ITTC nor committee members shall be liable for any losses and/or damages whatsoever in connection with the use of information available in the ITTC Recommended Procedures and Guidelines.**

Updated / Edited by	Approved
Quality Systems Group of the 28 <sup>th</sup> ITTC	23 <sup>rd</sup> ITTC 2002
Date: 07/2017	Date: 09/2002

	<b>ITTC – Recommended Procedures and guidelines</b>	<b>7.6-02 -04</b> Page 2 of 14	
	<b>Calibration of Micrometres</b>	Effective Date 2002	Revision 00

## Table of Contents

<p><b>1. PURPOSE ..... 4</b></p> <p><b>2. INTRODUCTION ..... 4</b></p> <p><b>3. SUBJECT AND CONDITION OF CALIBRATION..... 4</b></p> <p><b>3.1 SUBJECT AND MAIN TOOLS OF CALIBRATION..... 4</b></p> <p><b>3.2 CALIBRATION CONDITIONS ..... 5</b></p> <p><b>4. TECHNICAL REQUIREMENTS AND CALIBRATION METHOD ..... 7</b></p> <p><b>4.1 EXTERIOR..... 7</b></p> <p><b>4.2 REQUIREMENTS..... 7</b></p> <p style="padding-left: 20px;">4.2.1 Calibration method:..... 7</p> <p><b>4.3 RELATIONSHIP AMONG PARTS... 7</b></p> <p style="padding-left: 20px;">4.3.1 Requirements ..... 7</p> <p style="padding-left: 20px;">4.3.2 Calibration Method ..... 7</p> <p><b>4.4 AXIAL SLIDE MOVEMENT AND RADIAL SWAY OF MICROMETER BOLT..... 7</b></p> <p style="padding-left: 20px;">4.4.1 Requirements: ..... 7</p> <p style="padding-left: 20px;">4.4.2 Calibration Method ..... 8</p> <p><b>4.5 RELATIVE DEVIATION BETWEEN GAUGE BUTTON AND WORKING PLANE OF MICROMETER BOLT... 8</b></p> <p style="padding-left: 20px;">4.5.1 Requirements ..... 8</p> <p style="padding-left: 20px;">4.5.2 Calibration Method ..... 8</p>	<p><b>4.6 MEASURING FORCE ..... 9</b></p> <p style="padding-left: 20px;">4.6.1 Requirements: ..... 9</p> <p style="padding-left: 20px;">4.6.2 Calibration Method: ..... 9</p> <p><b>4.7 WIDTH AND WIDTH DIFFERENCE OF LINES..... 9</b></p> <p style="padding-left: 20px;">4.7.1 Requirements ..... 9</p> <p style="padding-left: 20px;">4.7.2 Calibration Method ..... 9</p> <p><b>4.8 RELATIVE POSITION OF INDICATOR NEEDLE AND DIAL ... 9</b></p> <p style="padding-left: 20px;">4.8.1 Requirements ..... 9</p> <p style="padding-left: 20px;">4.8.2 Calibration Method: ..... 10</p> <p><b>4.9 DISTANCE BETWEEN END FACE EDGE OF CONICAL SURFACE FOR DIFFERENTIAL TUBE AND ENGRAVED SURFACE OF FIXED SLEEVE ..... 10</b></p> <p style="padding-left: 20px;">4.9.1 Requirements: ..... 10</p> <p style="padding-left: 20px;">4.9.2 Calibration Method ..... 10</p> <p><b>4.10 RELATIVE POSITION BETWEEN CONICAL SURFACE END FACE OF DIFFERENTIAL TUBE AND MILLIMETRE LINE OF FIXED SLEEVE ..... 10</b></p> <p style="padding-left: 20px;">4.10.1 Requirements ..... 10</p> <p style="padding-left: 20px;">4.10.2 Calibration Method ..... 10</p> <p><b>4.11 SURFACE ROUGHNESS OF WORKING PLANE..... 10</b></p> <p style="padding-left: 20px;">4.11.1 Requirements ..... 10</p> <p style="padding-left: 20px;">4.11.2 Calibration Method ..... 11</p>
--	--

	<b>ITTC – Recommended Procedures and guidelines</b>	<b>7.6-02 -04</b> Page 3 of 14	
	<b>Calibration of Micrometres</b>	Effective Date 2002	Revision 00

<b>4.12 ACCURACY OF WORKING PLANE ..... 11</b> 4.12.1 Requirements ..... 11 4.12.2 Calibration Method ..... 11  <b>4.13 PARALLELISM OF TWO WORKING PLANES..... 11</b> 4.13.1 Requirements ..... 11 4.13.2 Calibration Method ..... 11  <b>4.14 ERROR OF INDICATION ..... 12</b> 4.14.1 Requirements ..... 12 4.14.2 Calibration Method ..... 13	<b>4.15 MEASURING ROD FOR CHECKING ..... 14</b> 4.15.1 Requirements ..... 14 4.15.2 Calibration Method ..... 14  <b>5. TREATMENT OF CALIBRATION RESULT AND CALIBRATION PERIOD ..... 14</b>  <b>5.1 TREATMENT OF CALIBRATION RESULTS..... 14</b>  <b>5.2 CALIBRATION PERIOD..... 14</b>
---	--

**Source:**

**Verification regulation of micrometer**

[Issued on Aug. 25, 1995 and put into effect since Feb. 1, 1996 by National Technical Bureau - **JJG 21—95, National Measuring Verification Regulation of People’s Republic of China**]

## Calibration of Micrometers

### 1. PURPOSE

This working instruction can be applied to the verification of micrometres for measuring outer diameter with the measuring range up to 500 mm and to micrometres for measuring plate or wall thickness with a measuring range up to 25 mm. It applies to new products with a scale division value of 0.01 mm, as well as those in service and after repair.

### 2. INTRODUCTION

The micrometre consists of a frame, a gauge button, a micrometre bolt, a force measuring device and a locking device, shown in Figures 1, 2, 3, 4, 5, 6 and 7 respectively.

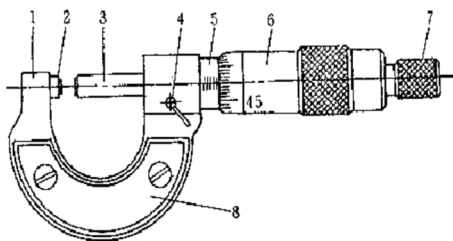

Figure 1 Micrometre with fixed gauge button. 1 frame, 2 gauge button, 3 micrometre bolt, 4 locking device, 5 fixed sleeve, 6 differential tube, 7 force measuring device, 8 thermal-protective installation

The micrometre is a metrology tool that uses the operating principle of the screw pair to trans-

fer the rotational movement into a linear movement. Its main usage is to measure different kinds of outside dimensions.

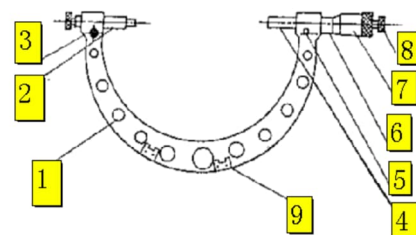

Figure 2 Micrometre with changeable or controllable gauge button. 1 frame, 2 gauge button, 3 fastening screw of gauge button, 4 micrometer bolt, 5 locking device, 6 fixed sleeve, 7 differential tube, 8 force measuring device, 9 thermal-protective installation

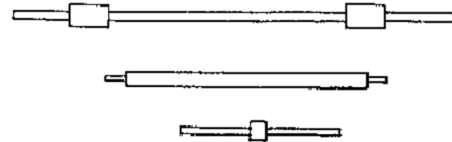

Figure 3 Measuring rod for checking

### 3. SUBJECT AND CONDITION OF CALIBRATION

#### 3.1 Subject and Main Tools of Calibration

The items and the main tools for the calibration of micrometers are listed in Table 1.

### 3.2 Calibration Conditions

Before the calibration the micrometer must be kept in room for temperature equilibrium and by the time of the calibration the room temperature must meet the requirements in Table 2.

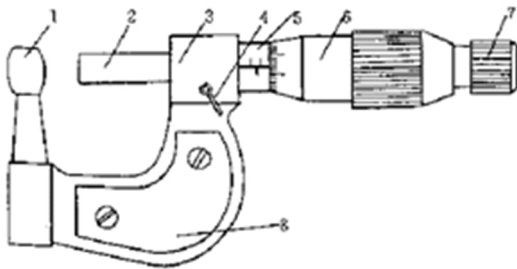

Figure 4 I-type micrometer for wall thickness measuring. 1 frame, 2 gauge button (spherical measuring cap shown in Figure), 3 micrometer bolt, 4 locking device, 5 fixed sleeve, 6 differential tube, 7 force measuring device, 8 thermal-protective installation

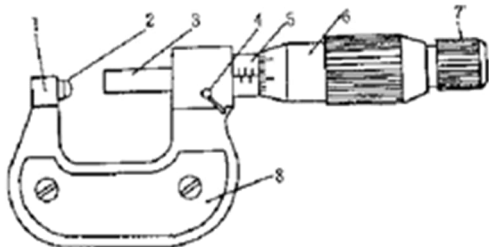

Figure 5 II-type micrometer for wall thickness measuring. 1 gauge button, 2 micrometer bolt, 3 frame, 4 locking device, 5 fixed sleeve, 6 differential tube, 7 force measuring device, 8 thermal-protective installation

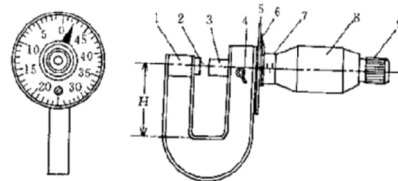

Figure 6 Micrometer for plate thickness measuring with dial. 1 frame, 2 gauge button, 3 micrometer bolt, 4 locking device, 5 dial, 6 point hand, 7 fixed sleeve, 8 differential tube, 9 force measuring device

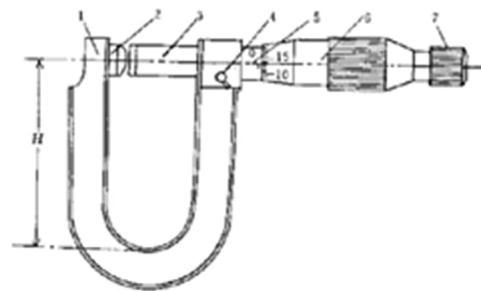

Figure 7 Micrometer for plate thickness measuring. 1 frame, 2 gauge button, 3 micrometer bolt, 4 locking device, 5 fixed sleeve, 6 differential tube, 7 force measuring device

 <b>ITTC</b> INTERNATIONAL TOWING TANK CONFERENCE	<b>ITTC – Recommended          Procedures and guidelines</b>	<b>7.6-02          -04</b> Page 6 of 14	
	<b>Calibration of Micrometres</b>	Effective Date 2002	Revision 00

Table 1

No	Items	Main calibration tools	Type of calibration		
			New product	In service	After repair
1	Exterior	-----	+	+	+
2	Relationship among parts	-----	+	+	+
3	Axial slide movement and radial sway of micrometer bolt	Level dial gauge with reading in 0.001mm	+	+	+
4	Relative deviation between gauge button and working plane of micrometer bolt	Levelling plane, level dial gauge or dial gauge with reading in 0.01mm	+	-	+
5	Measuring force	Force gauge for special use	+	+	+
6	Width and width difference of lines	Tool microscope	+	-	+
7	Relative position of point hand and dial	Plug gauge	+	+	+
8	Distance between end face edge of conical surface for differential tube and scratch plane of fixed sleeve	Tool microscope, plug gauge	+	-	+
9	Relative position between conical surface end face of differential tube and millimetre line of fixed sleeve	-----	+	+	+
10	Surface roughness of working plane	Sample block for comparison of surface roughness	+	-	+
11	Accuracy of working plane	Second class optical flat, first class tool edge ruler	+	+	+
12	Parallelism of two working planes	Parallel optical flat, fourth, fifth measuring block for special use	+	+	+
13	Error of indication	Fourth, fifth measuring blocks or relevant measuring block for special use	+	+	+
14	Measuring rod for checking	Optical metre, length measuring machine, fourth grade measuring block			

Note: “+” means calibration must be done; “-“ means calibration may not be done

	<b>ITTC – Recommended Procedures and guidelines</b>	<b>7.6-02 -04</b> Page 7 of 14	
	<b>Calibration of Micrometres</b>	Effective Date 2002	Revision 00

Table 2

Measured range of calibrated micrometer (mm)	Allowed temperature deviation based on 20° in room		Time for temperature balance (h)
	Micrometer	Measuring rod for checking	
~100	±5	±3	2
>100~500	±4	±2	3

## 4. TECHNICAL REQUIREMENTS AND CALIBRATION METHOD

### 4.1 Exterior

### 4.2 Requirements

The micrometer and the measuring rod should not have any mechanical damage, rust, any sign of being magnetized or any other fault. The graduation marks should be clear and well distributed.

The micrometer should have an attachment for the zero positioning. The micrometer with a range limit larger than 25 mm should have a measuring rod for checking its attachment.

The scale division value, the measuring range, the name or the mark of the manufacturer; and the serial number of production should be marked on the micrometer.

The micrometer and the measuring rod for checking in service and after repair should not have any exterior fault that affects its accuracy.

#### 4.2.1 Calibration method:

By eyesight.

## 4.3 Relationship Among Parts

### 4.3.1 Requirements

It should be possible for the differential tube and the micrometer bolt to be steadily rotated and moved without the occurrence of seizure.

It should be possible for the controllable or the changeable gauge button to be smoothly adjusted, as well as assembled and disassembled. It should work reliably. The function of the locking device should be effective.

The indicator needle of a dial micrometer should be freely movable without sticking.

### 4.3.2 Calibration Method

Tested and observed by eyesight.

## 4.4 Axial Slide Movement and Radial Sway of Micrometer Bolt

### 4.4.1 Requirements:

Both the axial slide movement and the radial sway of micrometer bolt should not exceed 0.01 mm.

#### 4.4.2 Calibration Method

The axial slide movement of the micrometer bolt can be calibrated by use of a level dial gauge with a reading of 0.001mm. During the calibration the level dial gauge should be kept touching the measuring surface of the micrometer bolt. A force of 3~5 N should be applied both in the forward and reverse direction of the axial bolt, as shown in Figure 8. The change of the indication of the level dial gauge is exactly the value of the axial slide movement.

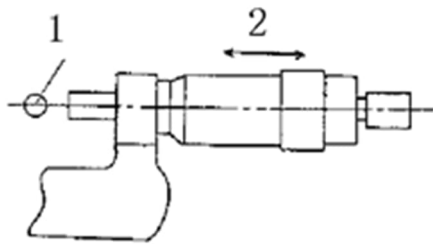

Figure 8. 1 level dial gauge with reading in 0.001mm, 2 direction of exerted force

The radial sway of the micrometer bolt can also be calibrated by use of a level dial gauge with a reading of 0.001 mm. During the calibration the micrometer bolt should be set 10 mm out of the frame. Then the level dial gauge should touch the end part of the bolt. A force of 2~3 N should be applied in the measuring direction of the level dial gauge and then in the reverse direction. The calibration should be carried out in two radial directions that are perpendicular to each other, as shown in Figure 9. The indicated change of the level dial gauge is the radial sway of the calibrated micrometer.

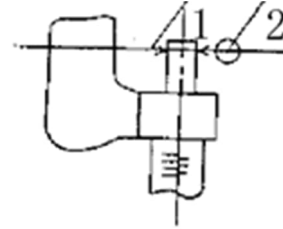

Figure 9. 1 direction of exerted force, 2 level micrometer

### 4.5 Relative Deviation Between Gauge Button and Working Plane of Micrometer Bolt

#### 4.5.1 Requirements

The relative deviation between the gauge button and the working plane of the micrometer bolt should not exceed the regulation in Table 3.

Table 3. (mm)

Measured range	Relative deviation between gauge button and working plane of bolt
0~25	0.10
25~50	0.15
50~75	0.20
75~100	0.30
100~200	0.40
200~300	0.50
300~400	0.80
400~500	1.00

#### 4.5.2 Calibration Method

The calibration should be carried out by use of a level dial gauge with the reading of 0.01 mm, on the levelling plane. Micrometers with a measuring range beyond 300 mm can be calibrated by use of a dial gauge with a reading of 0.01 mm. During the calibration the micrometer



should be positioned on a levelling plane using jacks, as shown in Figure 10.

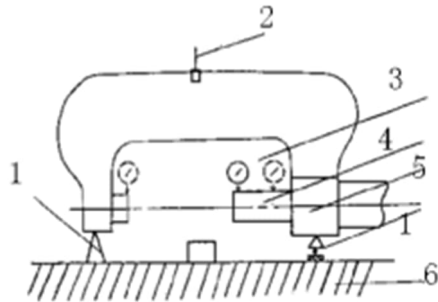

Figure 10. 1 jacks, 2 carriage, 3 level dial gauge (or dial gauge) with reading in 0.01mm, 4 micrometer bolt, 5 calibrated micrometer, 6 levelling plane

The jacks may be adjusted till the micrometer bolt is parallel to the working surface of the levelling plane. The deviation  $x$  between the gauge button and the micrometer bolt in this direction can then be measured by the dial gauge. After that the frame of the calibrated micrometer should be turned  $90^\circ$  in the lateral direction. Then the deviation  $y$  in the other direction can be measured as above. The relative deviation between the gauge button and the working plane of the micrometer bolt  $\Delta$  can be calculated by the following formula:

$$\Delta = \sqrt{x^2 + y^2}$$

This calibration can also be carried out by the use of other special instrumentation.

#### 4.6 Measuring Force

##### 4.6.1 Requirements:

The measuring force of the micrometer (that means the force exerted between the working

planes and the spherical surface when touching each other) should be in the range of 6~10N.

##### 4.6.2 Calibration Method:

The calibration can be carried out by use of a special force gauge, with a scale division value not larger than 0.2N. During the calibration the force should be measured when the working plane touches the spherical working surface of the force gauge.

#### 4.7 Width and Width Difference of Lines

##### 4.7.1 Requirements

The width of the longitudinal lines on the fixed sleeve and of the lines on the differential tube should be 0.15~0.20mm, The difference of their widths should not exceed 0.03 mm. The width of the lines on the dial should be 0.20~0.30 mm. The difference of their widths should not exceed 0.05mm.

##### 4.7.2 Calibration Method

The calibration can be performed by use of a tool microscope. At least three lines of the differential tube or of the dial should be selectively calibrated.

#### 4.8 Relative Position of Indicator Needle and Dial

##### 4.8.1 Requirements

The end of the indicator needle on the dial of the micrometer for the plate thickness measuring should cover 30~80% length of the short lines of the dial. The distance between the upper

	<b>ITTC – Recommended Procedures and guidelines</b>	<b>7.6-02 -04</b> Page 10 of 14	
	<b>Calibration of Micrometres</b>	Effective Date 2002	Revision 00

surface of the needle end edge and the surface of the dial should not exceed 0.7mm. The width of the needle end should coincide with the width of the lines on the dial. Their difference should not exceed 0.05mm.

#### 4.8.2 Calibration Method:

The relative positioning between the end of the indicator and the short lines on the dial can be estimated by eyesight. The distance between the upper surface of the indicator end and the surface of the dial can be calibrated by use of a plug gauge. The above-mentioned calibration should be carried out at three well-distributed positions of the dial. The difference between the end of the indicator needle and the lines of the dial can be calibrated on a tool microscope.

#### **4.9 Distance Between End Face Edge of Conical Surface for Differential Tube and Engraved Surface of Fixed Sleeve**

##### 4.9.1 Requirements:

The distance between the end face edge of the conical surface for the differential tube and the engraved plane of the fixed sleeve should not exceed 0.4mm.

##### 4.9.2 Calibration Method

It can be calibrated with a tool microscope or using the comparison method with a 0.4mm plug gauge positioned on the line surface of the fixed sleeve. The calibration should be carried out at least at three positions during one rotation of the differential tube.

#### **4.10 Relative Position Between Conical Surface End Face of Differential Tube and Millimetre Line of Fixed Sleeve**

##### 4.10.1 Requirements

After the lower measuring limit has been adjusted correctly, when the zero line of the differential tube points the longitudinal line of the fixed sleeve, the end face of the differential tube should come into contact with the right edge of the millimetre line on the fixed sleeve. If it does not come into contact, the line covering and the line separation must not exceed 0.05 mm and 0.1 mm respectively.

##### 4.10.2 Calibration Method

After the lower measuring limit has been adjusted correctly and the end face of the differential tube has been adjusted till it contacts with the right side of any millimetre line on the fixed sleeve, the deviation can be read between the zero line of the differential tube and the longitudinal line of the fixed sleeve.

#### **4.11 Surface Roughness of Working Plane**

##### 4.11.1 Requirements

The surface roughness Ra of the working planes of both of a micrometre for outer diameter measuring and the measuring rod used for checking, should not exceed 0.05µm. The surface roughness Ra of the working plane of a micrometre for measuring wall and plate thickness, should not exceed 0.10µm.

	<b>ITTC – Recommended Procedures and guidelines</b>	<b>7.6-02 -04</b> Page 11 of 14	
	<b>Calibration of Micrometres</b>	Effective Date 2002	Revision 00

#### 4.11.2 Calibration Method

It may be calibrated by using the method of comparison with a sample block, for the assessment of the surface roughness.

### 4.12 Accuracy of Working Plane

#### 4.12.1 Requirements

The working plane accuracy of zero class micrometres, used for outer diameter measurements, should not exceed  $0.6\mu\text{m}$ . Similarly for first class micrometres, used for the outer diameter measurements, should not exceed  $1\mu\text{m}$ . The working plane accuracy of the micrometre bolt of micrometres, used for wall thickness measurements, should not exceed  $1.2\mu\text{m}$ . The working plane accuracy of micrometres, used for plate thickness measurements, should not exceed  $1\mu\text{m}$ .

#### 4.12.2 Calibration Method

The calibration can be carried out by use of a second class optical flat on the basis of the optical interference method. The calibration of the micrometre in service can be carried out by use of a first class tool edge ruler on basis of the light test method. The working plane accuracy in the range of  $0.2\text{mm}$  from the edge for the micrometre, with a working plane diameter of  $6.5\text{mm}$ , cannot be taken into account. The working plane accuracy in the range of  $0.5\text{mm}$  from the edge for the micrometre, with the working plane diameter of  $8\text{mm}$ , cannot be taken into account.

### 4.13 Parallelism of Two Working Planes

#### 4.13.1 Requirements

The parallelism of the two working planes for the micrometre should not exceed the values in Table 4 when the locking device is fastened or loose.

The working plane parallelism of micrometres used for plate thickness measuring should not exceed  $2\mu\text{m}$ .

#### 4.13.2 Calibration Method

The parallelism of the two working planes of the micrometre, with the measuring limit up to  $100\text{mm}$ , can be calibrated using a parallel optical flat or a measuring block. The parallelism of two working planes of zero-class micrometres can be calibrated using a fourth grade-measuring block. The parallelism of the two working planes of first-class micrometres for outer diameter measuring and for micrometres for plate thickness measuring can be calibrated by a fifth grade measuring block. The parallelism of the two working planes of micrometres, with a measuring range up to  $100\text{mm}$ , can be calibrated using a steel ball trier as shown in Figure 11.

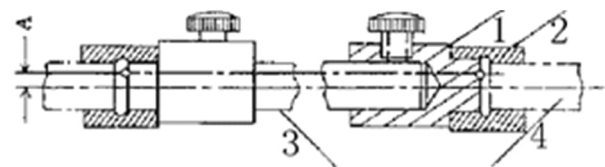



Figure 11. 1 additional measuring cap for special use, 2 connecting sleeve, 3 measuring implement for alignment (or measuring rod for special use), 4 measuring rod of micrometre

	<b>ITTC – Recommended Procedures and guidelines</b>	<b>7.6-02 -04</b> Page 12 of 14	
	<b>Calibration of Micrometres</b>	Effective Date 2002	Revision 00

Note:

A is 3.5 mm, when diameter of measuring rod is  $\phi$  8mm;

A is 3.0mm, when diameter of measuring rod is  $\phi$  6.5mm.

When measuring blocks are used for the calibration, four groups of measuring blocks should be prepared with the mean dimensions of the upper and lower limits and with an interval of one quarter rotation of the differential tube.. The values can be read from the differential tube when each group of the measuring blocks is put on the four positions between the working planes shown in Figure 12. The difference between them can then be obtained. The maximum of readings of the four groups can be taken as the parallelism of the two working planes of the calibrated micrometre.

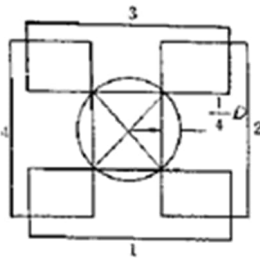

Figure 12

Table 4

Measured range (mm)	Parallelism ( $\mu$ m)	
	Zero class	First class
0~25	1.0	2.0
25~50	1.3	2.5
50~100	1.5	3.0
100~150	-----	4.0
150~200	-----	6.0
200~300	-----	7.0
300~400	-----	8.0
400~500	-----	10.0

#### 4.14 Error of Indication

##### 4.14.1 Requirements

The indication error of micrometres for outer diameter measuring should not exceed the limits in Table 5.

The indication error of the micrometres for plate and wall thickness measuring should not exceed  $\pm 4\mu$ m.

The parallelism of the two working planes can also be calibrated by use of other instrumentation with the relevant accuracy.

Table 5

Measured range (mm)	Indication error ( $\mu$ m)	
	Zero class	First class
0~100	$\pm 2$	$\pm 4$
100~150	-----	$\pm 5$
150~200	-----	$\pm 6$
200~300	-----	$\pm 7$
300~400	-----	$\pm 8$
400~500	-----	$\pm 10$

When a parallel optical flat is used for the calibration, four parallel optical flats with 0.25 pitch as thickness difference should be in turn located between the two working planes. The differential tube should be rotated till two working planes touch the parallel optical flats. Then the optical flat should be lightly rotated, until the number of interference lines on two working planes are reduced to the minimum. The number of interference lines on both working planes should be read respectively. The calculated result from the sum of both numbers and the wavelength of the light used, can be taken as the parallelism of the two working planes. Each of the optical flats should be used for the calibration

	<b>ITTC – Recommended Procedures and guidelines</b>	<b>7.6-02 -04</b> Page 13 of 14	
	<b>Calibration of Micrometres</b>	Effective Date 2002	Revision 00

according to the above-mentioned procedure. The maximum parallelism value of the measurements can be taken as the parallelism calibration result for the two working planes of the calibrated micrometre.

#### 4.14.2 Calibration Method

Zero class micrometres for outer diameter measuring can be calibrated by use of fourth grade measuring blocks or relevant grade meas-

uring blocks for special use. First class micrometres for outer diameter measuring and micrometres for plate and wall thickness measuring can be calibrated using fifth grade measuring blocks or relevant grade measuring blocks. The calibrated points of the various micrometres should be well distributed upon five positions in the measuring range, as shown in Table 6. The indication errors of all the positions should not exceed the values in Table 5

Table 6 (mm)

Measured range	Size of calibrated points				
0~10	2.12	4.25	6.37	8.50	10.00
0~15	3.12	6.24	9.37	12.50	15.00
0~25	5.12 or 5.12	10.25 10.24	15.37 15.36	20.50 21.50	25.00 25.00
>25	A+5.12 or A+5.12	A+10.25 A+10.24	A+15.37 A+15.36	A+20.50 A+21.50	A+25.00 A+25.00

Note: where A is the down measuring limit of the micrometre

For micrometres for outer diameter measuring with a measuring range of above 150mm, only the indication error of the micrometre head may be calibrated. This calibration can be carried out by fifth grade measuring blocks or relevant grade measuring blocks for special use by the help of a special trier with the relevant accuracy according to the calibrated points of micrometres with a measuring range of 0~25mm, as shown in Figure 13.

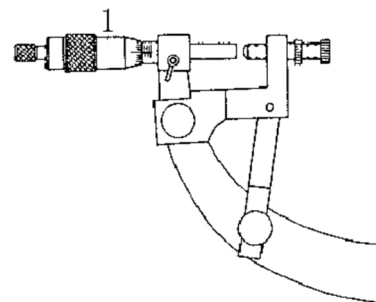

Figure 13. 1 micrometre head

#### 4.15 Measuring Rod for Checking

Table 7

##### 4.15.1 Requirements

The dimensional deviation and the parallelism of two working planes for the measuring rod should not exceed the values in Table 7.

Nominal dimension of rod (mm)	Size deviation ( $\mu\text{m}$ )		Parallelism of working planes ( $\mu\text{m}$ )
	Zero class	First class	
25	$\pm 1.0$	$\pm 2.0$	1.0
50	$\pm 1.5$	$\pm 2.0$	1.0
75	$\pm 1.5$	$\pm 2.0$	1.5
100~125	-----	$\pm 2.5$	2.0
150~175	-----	$\pm 3.0$	2.5
200~225	-----	$\pm 3.5$	3.5
250~275	-----	$\pm 3.5$	3.5
325~375	-----	$\pm 4.0$	4.0
425~475	-----	$\pm 5.0$	5.0

##### 4.15.2 Calibration Method

The dimension and the parallelism of the working planes for the measuring rod can be calibrated by using a fourth grade measuring block on the basis of the comparison method, when the rod is located in an optical meter or in a length measuring machine. For rods with flat working planes the calibration can be carried out by use of a spherical measuring cap at five positions as shown in Figure 14. The size deviation of every position should not exceed the limits in Table 7. The difference of the maximum and the minimum values among five positions is the parallelism of the two working planes of the rod.

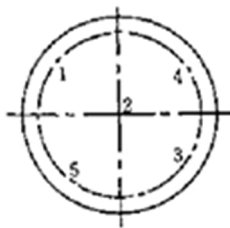

Figure 14

For rods with a spherical working surface, calibration can be carried out by use of a flat measuring cap having a diameter of 8mm.

## 5. TREATMENT OF CALIBRATION RESULT AND CALIBRATION PERIOD

### 5.1 Treatment of Calibration Results

For micrometers that meet the requirements of this working instruction, a calibration report will be supplied;

For the ones which do not meet the requirement, a notice of the calibration result will be supplied.

### 5.2 Calibration Period

The calibration period can be determined upon the service condition.