	ITTC – Recommended Procedures and Guidelines	7.5-02 -07-03.13 Page 1 of 10	
	Guideline for VIM Testing	Effective Date 2021	Revision 01

ITTC Quality System Manual Recommended Procedures and Guidelines

Guideline

Guideline for VIM Testing

7.5	Process Control
7.5-02	Testing and Extrapolation Methods
7.5-02-07	Loads and Responses
7.5-02-07-03	Ocean Engineering
7.5-02-07-03.13	Guideline for VIM Testing

Disclaimer

All the information in ITTC Recommended Procedures and Guidelines is published in good faith. Neither ITTC nor committee members provide any warranties about the completeness, reliability, accuracy or otherwise of this information. Given the technical evolution, the ITTC Recommended Procedures and Guidelines are checked regularly by the relevant committee and updated when necessary. It is therefore important to always use the latest version.

Any action you take upon the information you find in the ITTC Recommended Procedures and Guidelines is strictly at your own responsibility. Neither ITTC nor committee members shall be liable for any losses and/or damages whatsoever in connection with the use of information available in the ITTC Recommended Procedures and Guidelines.

Edited /Updated	Approved
Ocean Engineering Committee of the 29 th ITTC	29 th ITTC 2021
Date: 11/2020	Date: 06/2021



	ITTC – Recommended Procedures and Guidelines	7.5-02 -07-03.13 Page 2 of 10	
	Guideline for VIM Testing	Effective Date 2021	Revision 01

Table of Contents

<p>1. PURPOSE OF GUIDELINE 3</p> <p>2. GENERAL DESCRIPTION..... 3</p> <p>3. DEFINITIONS OF VARIABLES 3</p> <p>4. PARAMETERS 4</p> <p style="padding-left: 20px;">4.1 Nondimensional parameters..... 4</p> <p style="padding-left: 20px;">4.2 Model preparation 4</p> <p style="padding-left: 20px;">4.3 Mooring system 5</p> <p style="padding-left: 20px;">4.4 Environmental parameters..... 5</p> <p style="padding-left: 40px;">4.4.1 Waves 5</p> <p style="padding-left: 40px;">4.4.2 Currents 5</p> <p>5. DESCRIPTION OF THE TEST PROCEDURE..... 6</p>	<p>5.1 Test rig and experimental facility.... 6</p> <p>5.2 Measurement system and calibration 7</p> <p>5.3 Test procedure and data acquisition8</p> <p style="padding-left: 20px;">5.3.1 Pre-test considerations..... 8</p> <p style="padding-left: 20px;">5.3.2 Test procedure..... 8</p> <p style="padding-left: 20px;">5.3.3 Measured quantities 8</p> <p style="padding-left: 20px;">5.3.4 Data acquisition and data analysis8</p> <p style="padding-left: 20px;">5.3.5 Results presentation 9</p> <p>6. UNCERTAINTY ANALYSIS 9</p> <p>7. REFERENCES 9</p>
--	---

	ITTC – Recommended Procedures and Guidelines	7.5-02 -07-03.13 Page 3 of 10	
	Guideline for VIM Testing	Effective Date 2021	Revision 01

Guideline for VIM Testing

1. PURPOSE OF GUIDELINE

Bluff marine structural bodies such as risers, free-spanning pipelines, and offshore platforms with cylindrical members (e.g. spars, TLPs and semi-submersibles) can be subjected to vortex shedding in ocean currents. Vortex shedding induces periodic forces (or non-periodic forces, such as galloping) on the body, which can cause the body to oscillate both in-line (IL) and cross-flow (CF) directions.

If the vortex induced response mainly consists in elastic deformation of the structure, this phenomenon is known as Vortex Induced Vibration (VIV). The guideline for VIV tests can be found in the ITTC Recommended Guideline for VIV Testing (7.5-02-07-03.10). If the vortex induced responses mainly consist of rigid body motions such as a cross-flow motion of a platform, this response is denoted as Vortex Induced Motion (VIM).

The purpose of this guideline is to ensure that laboratory model tests of VIM of marine structures are adequately performed according to the best available techniques, and to provide an indication of improvements that might be made. The guideline is also to ensure that any compromise inherent in VIM tests are identified and their effects on the measured results are understood.

2. GENERAL DESCRIPTION

The main objective of a VIM test is to measure the motion of a model induced by vortices.

The experimental tests on VIM can be carried out with a rigid model of the structure,

which is elastically mounted. The model can either be towed in a towing tank (normally in calm water) or tested in a tank with current. This type of tests can be used to study VIM of rigid floating offshore structures such as spars and semi-submersibles.

3. DEFINITIONS OF VARIABLES

Typical variables used in VIM tests are defined below:

<i>A</i>	Displacement amplitude
A_{CF}	Cross-flow response amplitude
<i>B</i>	Width of a test tank
<i>CF</i>	Cross-flow
<i>D</i>	Characteristic CF dimension such as the column diameter
<i>DOF</i>	Degree of freedom
F_n	Froude number, $F_n = \frac{U}{\sqrt{gD}} (Lg)^{\frac{1}{2}}$
f_n	Natural frequency in still water
<i>g</i>	Gravitational acceleration
<i>IL</i>	In-Line
<i>L</i>	Characteristic length
<i>M</i>	Mass
<i>Re</i>	Reynolds number, $Re = \frac{UD}{\nu}$
T_n	Natural period of the structure in still water
<i>U</i>	Flow speed
U_r	Reduced velocity, $U/f_n D$
<i>V</i>	Volume of displacement
VIM	Vortex Induced Motions
VIV	Vortex Induced Vibrations
ρ	Water density
ν	Kinematic viscosity coefficient

	ITTC – Recommended Procedures and Guidelines	7.5-02 -07-03.13 Page 4 of 10	
	Guideline for VIM Testing	Effective Date 2021	Revision 01

4. PARAMETERS

4.1 Nondimensional parameters

The following nondimensional parameters should be considered when choosing the scaling law in a VIM experiment, to ensure geometrical, kinematic, and dynamic similarities.

The model- and full-scale dimensions should be expressed in a nondimensional manner such as B/T and L/B for the beam to draft and length to beam ratios, respectively.

Reduced velocity,
$$U_r = \frac{U}{f_n D} = \frac{UT_n}{D} U_r = \frac{U}{f_n D}.$$

Non-dimensional response amplitude, $\frac{A}{D}$. For example, the non-dimensional cross-flow response is denoted as $\frac{A_{CF}}{D}$.

Mass ratio,
$$m' = \frac{M}{\rho V}$$

Reynolds number,
$$Re = \frac{UD}{\nu}$$

Froude number,
$$F_n = \frac{U}{\sqrt{gD}} = \frac{U}{(Lg)^{\frac{1}{2}}}.$$

Froude scaling is typically used for VIM tests. As Reynolds number will not be properly scaled, it is important to simulate the turbulent flow regime by using turbulence stimulation techniques (for example, by augmenting surface roughness).

The vortex shedding will lead to dynamic forces and moments in both IL and CF direction. A floating platform with moorings will therefore be excited in all 6 degrees of freedom (DOFs). Natural periods in surge, sway and yaw are typically of importance for VIM and should be correctly scaled. If the other DOFs (heave, roll, and pitch) are excited by the vortex shedding loads,

the mooring system should properly account for these cross-couplings, but with highlight on the main surge-sway excitation.

It should be noticed that the Keulegan-Carpenter number is an important parameter for oscillating flow, which is common for riser VIV studies due to the fluid particle motions induced by waves, and the oscillating sway/surge motions induced by top-end platform motions. However, it is rarely the case for floating offshore platforms, because for wave-induced motions of floating offshore platforms, the effect of oscillating flow can be neglected.

4.2 Model preparation

A geometrically similar model of a full-scale design is constructed at a scale compatible with the facility capabilities and should be modelled following the Froude scaling law. The inertial characteristics (mass, centre of gravity, moments of inertia) must be modelled according to Froude scaling law.

The model geometry can be simplified, if there is minimal impact on the physical phenomenon to be measured, particularly the boundary layer of the flow. Appendages such as anodes and strakes may be sized to consider proper viscous effects (Roddier et al., 2009).

The geometry may be modified to consider marine growth (bio-fouling) in terms of effective diameter and surface roughness. Since the use of organic materials is often not allowed in a laboratory, the artificial marine growth should be modelled and manufactured, including both hard and soft marine growths. Soft marine growth can be modelled by using different types of fabrics/carpet. To simulate hard marine growth in the laboratory, sandpaper, coarse sand and gravel of different sizes, metal coatings, and others can be used (Zeinoddini et al., 2016).

	ITTC – Recommended Procedures and Guidelines	7.5-02 -07-03.13 Page 5 of 10	
	Guideline for VIM Testing	Effective Date 2021	Revision 01

4.3 Mooring system

The mooring system of a floating platform provides restoring forces and moments. In a VIM model test, it is often modelled as a linear or non-linear spring system. Care must be taken if a linear spring system is used to approximate a non-linear system.

The mooring system will also contribute to the damping of the platform, due to the viscous forces acting on the mooring lines when they move in the water. The mooring line damping may reduce the VIM effects (Irani et al., 2015; Huang and Chen, 2020), as also highlighted by the results of a JIP on VIM (Koop et al., 2016). To include this damping effect in a VIM model test, a correct scaled geometry/stiffness of the mooring system is required. For deep water mooring systems, a truncated model may be used as described in Procedures 7.5-02-07-03.5 Passive Hybrid Model Tests of Floating Offshore Structures with Mooring Lines.

4.4 Environmental parameters

Current and waves are often the environmental parameters to be considered in VIM tests.

When waves are present together with current, it is expected that waves will generally reduce the VIM related responses compared to the pure current conditions (Gonçalves et al., 2013). The wave effects on the VIM phenomenon could be further analyzed, see (Gonçalves and Pinto, 2018; Gonçalves et al., 2020).

4.4.1 Waves

In the cases where waves are present, the wave height (spectrum) should be measured at the location of the offshore structure model before it is installed, to ensure the accuracy of the generated waves. Other upstream wave probes and those abreast the model should be used to

ensure that also the phasing, the spatial distribution, and the elevation of the waves are the desired ones.

The repeatability of the generated waves should be checked, and wave calibrations should be documented. Aspects of the wave calibration and instrumentation can be found in Procedures 7.5-02-07-03.1 Floating Offshore Platform Experiments, 7.5-02-07-03.2 Analysis Procedure Model Tests in Regular Waves, and 7.5-02-07-03.13 Analysis Procedure Model Tests in Irregular Waves.

4.4.2 Currents

Ocean current velocity varies in both space and time. To test a complete mooring system, a vertical profile of the current is derived from metocean data. Considering the capability of the facility, the simulation of a vertical profile can be performed neglecting the variations in direction and in time, but this should be clearly documented.

The current is typically described as a mean (constant) speed plus a time varying component. However, for practical reasons in VIM tests, it is preferred to perform the tests with a constant speed.

The current can either be simulated by re-circulating water around the model or towing the model using a carriage.

In the former case, the current must be calibrated prior to the test. The current profile should be calibrated at the planned location of the model. The current velocity should be measured at least at a depth corresponding to half draft of the platform and in a sufficient number of locations abreast of the model.

Uniform- or sheared- flow profiles may be generated. The profile and the turbulence intensity level should be documented. Details can be

 ITTC INTERNATIONAL TOWING TANK CONFERENCE	ITTC – Recommended Procedures and Guidelines	7.5-02 -07-03.13 Page 6 of 10	
	Guideline for VIM Testing	Effective Date 2021	Revision 01

found in Procedure 7.5-02-07-03.1 Floating Offshore Platform Experiments.

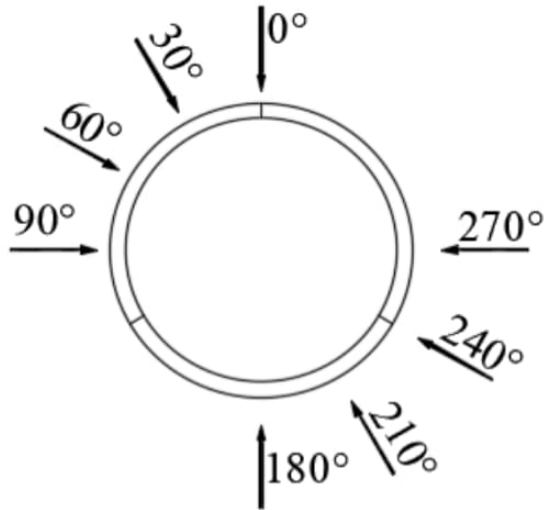

(a) Spar with helical strakes

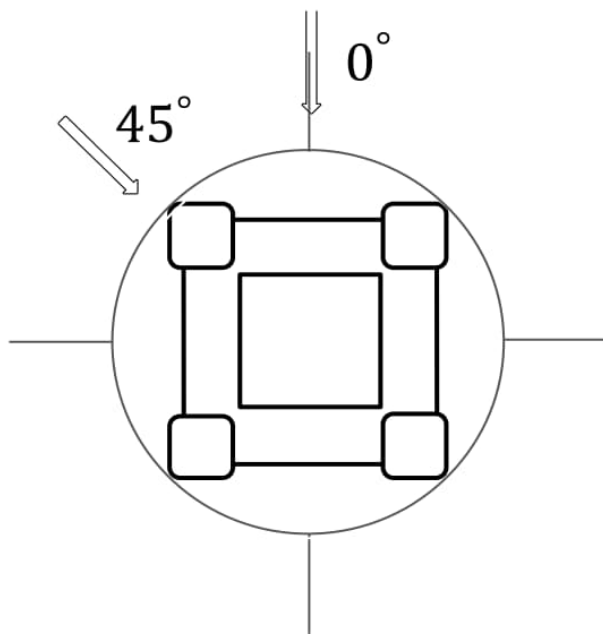

(b) Semisubmersible

Figure 1. Definition of current direction.

The generation of waves superimposed to the current in a circulating water channel is not recommended for VIM tests.

When using a carriage to tow the model, the carriage speed must be calibrated prior to the test. It is required to verify the flow regime seen by the model for every test configuration when waves and a towing speed are involved. The definition of current directions for VIM test should be documented. Examples can be found in Lefevre et al. (2013), Zhao and Wan (2016) – Fig. 1.

According to the work of Gonçalves et al. (2013), VIM only exists if the inertia forces are lower than the drag forces and such a situation can vary with the wave characteristics such as wave steepness.

5. DESCRIPTION OF THE TEST PROCEDURE

5.1 Test rig and experimental facility

VIM tests can be performed by towing a model with a horizontal mooring system or by re-circulating the water around a model with a mooring system in an ocean wave basin, as described in Liu et al. (2017) and Hong et al. (2008), respectively.

For towing tests of TLP or semi-submersible production platforms with mass ratios lower than 1.0, an experimental setup using air bearings (see Fig. 2) can be employed to provide vertical pretensions arising from the mooring and riser system, and allow the model to move freely in the horizontal plane. For spars and semi-submersible drilling platforms, the mass ratio is close to 1.0 and the model can be towed directly for VIM tests.

 INTERNATIONAL TOWING TANK CONFERENCE	ITTC – Recommended Procedures and Guidelines	7.5-02 -07-03.13 Page 7 of 10	
	Guideline for VIM Testing	Effective Date 2021	Revision 01

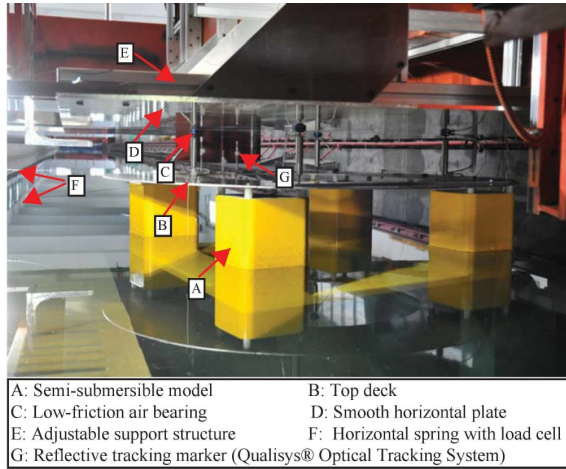

Figure 2. Example of a VIM test setup for a semi-submersible in the towing tank.

For towing tests of TLP or semi-submersible production platforms with mass ratios lower than 1.0, an experimental setup using air bearings (see Fig. 2) can be employed to provide vertical pretensions arising from the mooring and riser system, and allow the model to move freely in the horizontal plane. For spars and semi-submersible drilling platforms, the mass ratio is close to 1.0 and the model can be towed directly for VIM tests.

It is crucial to check the dimensions of the facility to avoid blockage effects from the walls and bottom of the tank. The expected dimensions of the model and the associated testing rig should be checked, preferably by numerical simulations, to ensure accurate flows around the structures.

The natural frequencies of the test rig should not approach the VIM response frequencies. The natural frequencies of the test rig should be significantly greater than the highest VIM response frequency (1.5 to 2 times, at least). This can be done at the design stage by FEM analyses and/or experimentally, by using accelerometers and spectral analysis.

For elastically mounted rigid cylinder tests, the test rig should be designed such that, at least, 3 DOFs are allowed (surge, sway, and yaw).

5.2 Measurement system and calibration

The instrumentation should be able to measure, at least, rigid body motions, accelerations, and tensions in springs or mooring lines.

To better represent the VIM characteristics, results of motion response time series could be analyzed. The definitions of motion response time series (Zhao et al., 2018) are listed below:

$$(A_x/D)_{rms} = \frac{\sqrt{2}RMS(A_x(t))}{D}$$

$$(A_y/D)_{rms} = \frac{\sqrt{2}RMS(A_y(t))}{D}$$

$$(Yaw)_{rms} = \sqrt{2}RMS(yaw(t))$$

$$(A_x/D)_{std} = \frac{\sqrt{2}\sigma(A_x(t))}{D}$$

$$(A_y/D)_{std} = \frac{\sqrt{2}\sigma(A_y(t))}{D}$$

$$(Yaw)_{std} = \sqrt{2}\sigma(yaw(t))$$

where RMS and σ are the root mean square and standard deviation of the motion time series, respectively, $A_x(t)$, $A_y(t)$ and $Yaw(t)$ are time histories for inline, transverse and yaw motions, respectively.

Further information on measurement systems and calibration may be found in Procedures 7.5-02-07-03.1 Floating Offshore Platform Experiments.

	ITTC – Recommended Procedures and Guidelines	7.5-02 -07-03.13 Page 8 of 10	
	Guideline for VIM Testing	Effective Date 2021	Revision 01

5.3 Test procedure and data acquisition

5.3.1 Pre-test considerations

After the model and instrumentation installation and before the experiment, the performance and the sign convention of all transducers and gauges should be confirmed by applying a known load or displacement.

The process should be recorded through the data acquisition system and stored for quality assurance purposes. The measured results should be compared to the applied quantities. It is important to carry out decay tests to check the rigid body natural periods of motions (at least for surge, sway, and yaw).

5.3.2 Test procedure

When the test program starts, it is important that the data acquisition process, for each run, starts from calm water and ends in calm water, when this is easily achieved. This will serve as an additional check on the performance of instrumentation and will reveal any zero drift.

The usual procedure for tests in a towing tank or a circulating water channel is based on steady towing speed /current velocity.

For waves and current VIM tests, current should be generated first and kept steady while the waves are generated through sequences.

Care should be taken to reach stationary flow regimes and to avoid transient phenomena affecting the motion of the structure (when there is a change of speed, for example).

5.3.3 Measured quantities

Typical measured quantities in VIM tests are:

- Rigid-body linear and rotational displacements, velocities and accelerations;

- Mooring tensions;
- Current velocity;
- Free-surface elevations (in case of waves).

5.3.4 Data acquisition and data analysis

These quantities should be collected digitally. The sample rate should be high enough to capture the physical phenomenon being measured, i.e., the sample frequency should be at least ten times higher than the highest frequency of interest (10 times is a good practice) to avoid signal folding.

In general, the data should be low-pass or band-pass filtered. The cut-off frequencies should not eliminate the desired data. The digital filters should be checked to avoid phase lags and modifications of the amplitudes of the signal components.

Furthermore, the test runs must be long enough to collect a statistically valid sample, which is supposed to cover at least 20 oscillating periods. If different sampling intervals are used, care should be taken to ensure synchronization of the measured signals. For rarely occurring events, individual runs for a given test condition (using, for instance, different seeds in the wave time series generation) can be concatenated to develop a long enough record for statistical analyses.

The total hydrodynamic forces acting on the structure is the sum of the inertial, dissipative, and restoring forces. For verification purposes, drag and lift forces can be extracted from the measurements of mooring line tensions, taking the structure motions into account (Liu et al., 2016). The nondimensional mean drag coefficient and fluctuating lift coefficient are given by:

$$C_D = \frac{\bar{F}_D}{0.5\rho LDU^2}$$

$$C'_L = \frac{\bar{F}'_L}{0.5\rho LDU^2}$$

	ITTC – Recommended Procedures and Guidelines	7.5-02 -07-03.13 Page 9 of 10	
	Guideline for VIM Testing	Effective Date 2021	Revision 01

where ρ is the flow density, \overline{F}_D is the mean drag force, \overline{F}_L' is the root-mean-square (RMS) value of the lift force, U is the current velocity, D is the characteristic CF dimension, L is the characteristic length in depth.

Further details on the procedure to obtain the response characteristics can be found in Procedure 7.5-02-07-03.2 Analysis Procedure for Model Tests in Regular Waves and Procedure 7.5-02-07-03.13 Analysis Procedure for Model Tests in Irregular Waves.

5.3.5 Results presentation

For engineering applications, results can be presented in dimensional form. To check the results and compare them with the databases, it is recommended to record and present the responses in a non-dimensional form. Linear motions may be divided by a characteristic length of the structure, such as the outer diameter of the tested cylinder.

In some situations, the response can be sinusoidal, while in other cases it can appear more irregular. Data analysis should be presented both in the time- and frequency- domain.

6. UNCERTAINTY ANALYSIS

Many parameters cause uncertainties in VIM tests. Sources of uncertainties can be found in Qiu et al. (2014).

Furthermore, uncertainty analysis should be performed in accordance with Procedure 7.5-02-01-01 Guide to the Expression of Uncertainty in Experimental Hydrodynamics.

7. REFERENCES

Gonçalves, R.T., Rosetti, G.F., Fajarra, A.L.C., Oliveira, A.C., 2013, “Experimental Study

on Vortex-Induced Motions of a Semi-Submersible Platform with Four Square Column, Part II: Effects of Surface Waves, External Damping and Draft Condition”, Ocean Engineering, Vol. 62, pp. 10-24.

Gonçalves, R.T., Pinto, L.A., 2018, “Concomitant wave and current effects on vortex-induced motion (VIM) of a large-volume semi-submersible platform, Proceedings of the Twenty-Eighth (2018) International Ocean and Polar Engineering Conference, Sapporo, Japan, June 10-15, 2018, pp. 954–960.

Gonçalves, R. T., Pinto, L. A., Fajarra, A. L. 2020, “Experimental study on vortex-induced motions of a semi-submersible platform with four square columns, part III: Effects of the collinear irregular and regular wave incidence and current”, Ocean Engineering, 217, 107585.

Hong, Y., Choi, Y., Lee, J., Kim, Y., 2008. “Vortex-induced motion of a deep-draft semisubmersible in current and waves”, Proceedings of the 18th International Offshore and Polar Engineering Conference, Vancouver, BC, Canada.

Irani, M., Jennings, T., Geyer J., Krueger E., 2015. “Some Aspects of Vortex Induced Motions of a Multi-Column Floater”, Proceedings of the ASME 34th International Conference on Offshore, Ocean and Arctic Engineering, St John’s, Canada.

Huang, H., Chen, H. C., 2020, “Investigation of mooring damping effects on vortex-induced motion of a deep draft semi-submersible by coupled CFD-FEM analysis”, Ocean Engineering, 210, 107418.

Koop, A., de Wilde, J., Fajarra, A.L.C., Rijken, O., Linder, S., Lennblad, J., Haug, N., Phadke, A., 2016. “Investigation on Reasons

	ITTC – Recommended Procedures and Guidelines	7.5-02 -07-03.13 Page 10 of 10	
	Guideline for VIM Testing	Effective Date 2021	Revision 01

for Possible Difference Between VIM Response in the Field and in Model Tests”. Proceedings of the ASME 34th International Conference on Offshore, Ocean and Arctic Engineering, Pusan, Korea.

Lefevre, C., Constantinides, Y., Kim, J.W., Henneke, M., Gordon, R., Jang, H., Wu, G., 2013, Guidelines for CFD Simulations of Spar VIM, Vol. 7: CFD and VIV. ASME, p. V007T08A019.

Liu M., Xiao L., Lu H. and Shi J., 2016, “Experimental investigation into the influences of pontoon and column configuration on vortex-induced motions of deep-draft semi-submersibles”, Ocean Engineering, Vol. 123, pp. 262-277.

Liu M., Xiao L., Liang Y. and Tao L., 2017, “Experimental and numerical studies of the pontoon effect on vortex-induced motions of deep-draft semi-submersibles”, Journal of Fluids and Structures, Vol. 72, pp. 59-79.

Qiu, W., Sales, J.J., Lee, D., Lie, H., Magarovskii, V., Mikami, T., Rousset, J.M., Sphaier, S., Wang, X., 2014, “Uncertainties Related to Predictions of Loads and Responses for Ocean and Offshore Structures”, Ocean Engineering, Vol. 86, pp. 58-67.

Roddier, D., Finnigan, T., Liapis, S., 2009. “Influence of the Reynolds Number on Spar Induced Motions (VIM): Multiple Scale Model Test Comparisons”, Proceedings of the ASME 28th International Conference on Offshore, Ocean and Arctic Engineering, Honolulu, USA.

Zeinoddini, M., Bakhtiari, A., Ehteshami, M., Seif, M.S., 2016, Towards an Understanding of the Marine Fouling Effects on VIV of Circular Cylinders: Response of Cylinders with Regular Pyramidal Roughness, Applied Ocean Research, vol. 59, pp 378-394.

Zhao, W., Wan, D.C., 2016, “Numerical Computations of Spar Vortex-Induced Motions at Different Current Headings”, Proceedings of the Twenty-Sixth (2016) International Ocean and Polar Engineering Conference, Rhodes, Greece, pp. 1122–1127.

Zhao, W., Zou, L., Wan, D.C., Hu, Z., 2018, “Numerical investigation of vortex-induced motions of a paired-column semi-submersible in currents”, Ocean Engineering, 2018, 164: 272–283.