	ITTC – Recommended Procedures and Guidelines	7.5-02 -07-03.10 Page 1 of 16	
	Guideline for VIV Testing	Effective Date 2021	Revision 01

ITTC Quality System Manual Recommended Procedures and Guidelines

Guideline

Guideline for VIV Testing

7.5	Process Control
7.5-02	Testing and Extrapolation Methods
7.5-02-07	Loads and Responses
7.5-02-07-03	Ocean Engineering
7.5-02-07-03.10	Guideline for VIV Testing

Disclaimer

All the information in ITTC Recommended Procedures and Guidelines is published in good faith. Neither ITTC nor committee members provide any warranties about the completeness, reliability, accuracy or otherwise of this information. Given the technical evolution, the ITTC Recommended Procedures and Guidelines are checked regularly by the relevant committee and updated when necessary. It is therefore important to always use the latest version.

Any action you take upon the information you find in the ITTC Recommended Procedures and Guidelines is strictly at your own responsibility. Neither ITTC nor committee members shall be liable for any losses and/or damages whatsoever in connection with the use of information available in the ITTC Recommended Procedures and Guidelines.

Edited /Updated	Approved
Ocean Engineering Committee of the 29 th ITTC	29 th ITTC 2021
Date 11/2020	Date 062021



	ITTC – Recommended Procedures and Guidelines	7.5-02 -07-03.10 Page 2 of 16	
	Guideline for VIV Testing	Effective Date 2021	Revision 01

Table of Contents

1. PURPOSE OF GUIDELINE 3 1.1 Lock-in vibration 4 2. TEST TYPES 4 3. DEFINITIONS OF VARIABLES 5 4. PARAMETERS 5 4.1 Scaling 5 4.2 Model geometry..... 7 4.3 Suppression devices..... 7 4.4 Marine growth..... 8 4.5 Riser interaction..... 8 4.6 Environmental parameters..... 9 4.7 Internal flows 10 5. DESCRIPTION OF THE TEST PROCEDURE..... 10	5.1 Model test objective 10 5.2 Test rig..... 10 5.3 Measurement system and calibration 11 5.4 Test procedure and data acquisition 11 5.4.1 Pre-test considerations..... 11 5.4.2 Test procedure..... 12 5.4.3 Measured quantities 12 5.4.4 Data analysis 12 5.4.5 Decay and pluck tests in air..... 13 5.4.6 Decay and pluck tests in water 13 5.4.7 Pluck test on test rig 13 6. UNCERTAINTY ANALYSIS 13 7. REFERENCES 13
----------------------------------------------------------------------------------------------------------------------------------------------------------------------------------------------------------------------------------------------------------------------------------------------------------------------------------------------------------------------------------------------------------------------------------------------------------------------------------------------------------------------------------	-------------------------------------------------------------------------------------------------------------------------------------------------------------------------------------------------------------------------------------------------------------------------------------------------------------------------------------------------------------------------------------------------------------------------------------------------------------------------------------------------------------------------------------------------------------

 INTERNATIONAL TOWING TANK CONFERENCE	ITTC – Recommended Procedures and Guidelines	7.5-02 -07-03.10 Page 3 of 16	
	Guideline for VIV Testing	Effective Date 2021	Revision 01

Guideline for VIV Testing

1. PURPOSE OF GUIDELINE

Bluff marine structural bodies such as the risers, free spanning pipelines, and offshore platforms with cylindrical members (e.g., spars, TLPs and semi-submersibles) can undergo vortex shedding in ocean currents. The vortex shedding process and vortices induce periodic forces on the body which can cause the body to vibrate in both in-line (IL) and cross-flow (CF) directions.

If the vortex-induced response mainly causes elastic deformation in marine structures, such as risers, cables and free spanning pipelines, this phenomenon is known as Vortex Induced Vibrations (VIV). If the vortex induced response mainly causes rigid body motions such as a cross-flow motion of a platform, this response often is denoted as Vortex Induced Motion (VIM).

The purpose of this guideline is to ensure that laboratory model tests of VIV responses of marine structures are adequately performed according to the best available techniques and to provide an indication of improvements that might be made. The guideline is also to ensure that any compromises inherent to VIV tests are identified and their effects on the measured results are understood.

VIV motions are typically at higher frequencies than VIM motions. The main consequences of VIV and VIM are to increase fatigue damage and drag loads. More description of VIV and VIM can be found in the work of Blevins, (1990), Sarpkaya (2004), Sumer and Fredsøe (2006), Wan and Duan (2017), Liu et al. (2020).

The amplitude of VIV depends on many factors, including the level of structural damping, the relative mass of the body to the displaced

water mass (the so-called “mass ratio”), the magnitude of the fluid forces, and the proximity of the vortex shedding frequency to the natural frequency of vibration of the body. A typical sequence of VIV study is illustrated in Figure 1.

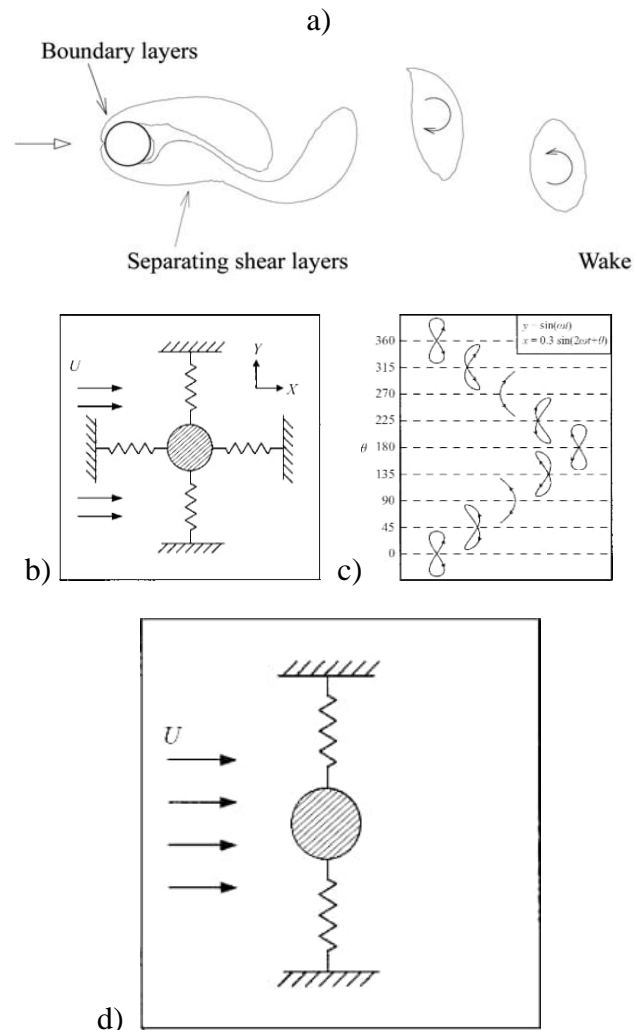

Figure 1. a) Vortex shedding due to boundary layer separation, which results in oscillating drag and lift forces on the body. For the idealised mass-spring setup shown in b), these oscillating drag and lift forces lead to response modes shown in c). As the cross-flow response is typically larger than the in-line response, most studies concentrate on the cross-flow response illustrated by the test setup shown in d). Willden (2003) and Jauvtis and Williamson (2004).

For a fixed, rigid circular cylinder in a uniform flow normal to its axis, the vortex-shedding frequency (or Strouhal frequency) acting in CF direction is given by $f_{St} = S_t U / D$ (Hz), where S_t is the Strouhal number, U is the incident flow velocity, and D is the diameter of the cylinder. The Strouhal number is a function of the Reynolds number, $Re = UD/\nu$, where ν is the kinematic viscosity. In the sub-critical range, the S_t value is around 0.2. In the critical range, it varies and can be in the range of 0.2 - 0.5. In the super-critical range, it is typically around 0.2 - 0.3.

1.1 Lock-in vibration

If the natural frequency of the body in CF direction is close to the Strouhal frequency, *lock-in* or *synchronisation* may happen. In this case vortices are shed at the actual frequency of oscillation rather than at the Strouhal frequency. In other words, it is the motion of the body that controls the frequency of vortex shedding. The frequency of oscillation may not be exactly equal to the expected resonant frequency of the cylinder in calm water. This is because the process of forming and shedding vortices alters the added mass of the cylinder. The change in added mass will be different from the still water value, causing the resonant frequency to shift. The change in added mass can be negative or positive, causing the natural frequency to increase or decrease. The damping will increase with the amplitude of oscillation increased and will cause the VIV amplitude to be moderate. Typical maximum CF amplitude is around one diameter of the cylinder. Marine structures, such as risers, normally have low mass ratios because of larger density of water, in comparison to structures in air which have high mass ratios.

A similar response can also be observed in the IL direction, as indicated in Figure 1b. In addition to the mean drag force the shedding process will generate dynamic forces which have frequency around twice of the Strouhal frequency. If the cylinder has a natural frequency

in IL direction which is about two times the Strouhal frequency, the cylinder will experience IL motions. The amplitude of the IL motion is less than that of the CF motion with a typical value of about 0.1 - 0.2 of the diameter.

The lock-in phenomenon is illustrated in Figure 2 for a case with low mass ratio, with respect to the setup shown in Figure 1d). Note that the vortex shedding is dominated by the Strouhal frequency outside the reduced velocity band at which lock-in occurs.

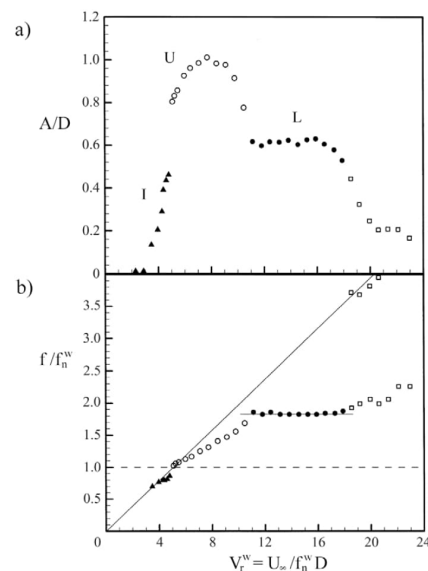



Figure 2. Cross-flow VIV behaviour of an elastically supported circular cylinder with low structural damping and low mass ratio for the setup shown in Figure 1d, Govardhan and Williamson (2000). Figure a) shows the amplitude to diameter ratio vs. reduced velocity ($V_r = U / (f_n^w D)$) where f_n^w = natural frequency in still water; Figure b) shows the oscillation and vortex shedding frequencies.

2. TEST TYPES

The experimental tests on VIV can be categorized into two different types:

- 2D tests of rigid cylinders with various geometric shapes (e.g., bare cylinders and cylinders with strakes or fairings) that are elastically mounted or forced to oscillate. The

 INTERNATIONAL TOWING TANK CONFERENCE	ITTC – Recommended Procedures and Guidelines	7.5-02 -07-03.10 Page 5 of 16	
	Guideline for VIV Testing	Effective Date 2021	Revision 01

cylinder can either be towed in a towing tank (normally in calm water) or tested in a tank with current. This type of tests can be used to study VIV characteristics of one short section of an elastic structure such as a riser.

- 3D tests of long flexible pipes with varying geometries and boundary conditions. The test arrangements have made it possible to create various flow conditions and current profiles. This type of test is typically used to study VIV of risers, umbilicals, free span pipelines and cables. It can also include realistic boundary conditions, for example, the seabed for a steel catenary riser (SCR). Tests in laboratory will typically be in small scale. Field experiments can be in larger scale.

Some aspects of preparing the models for VIV tests can be found in the ITTC Recommended Procedure for Floating Offshore Platform Experiments (7.5-02-07-03.1).

In addition, tests can be carried out in wind tunnel to determine the coefficients for mean forces/moments. In these cases, the data for full-scale Reynolds numbers can be obtained.

3. DEFINITIONS OF VARIABLES

Typical variables used in VIV tests are defined below:

A	Displacement amplitude
B	Damping or width of the test tank
C_D	Drag coefficient
C_e	Exciting force coefficient
C_L	Lift coefficient
C_m	Added mass coefficient
CF	Cross-flow
D	Characteristic CF dimension such as cylinder diameter
E	Bulk modulus elasticity
f	Frequency (Hz)
\hat{f}	Non-dimensional frequency, $f_{osc}D/U$
$\overline{F_D}$	Mean drag force

$\overline{F_L}$ Mean lift force

F_r Froude number, $F_r = \frac{U}{\sqrt{gD}} (Lg)^{\frac{1}{2}}$

f_{St} Strouhal frequency $S_t U/D$

f_n Natural frequency in still water

f_{osc} Oscillating frequency

g Gravitational acceleration

IL In-Line

k Characteristic cross-sectional dimension of the roughness on the body surface

KC Keulegan-Carpenter number of oscillatory flow, U_m/fD

k/D Roughness number

L Cylinder length, characteristic length

M Mass

Re Reynolds number, UD/ν

St Strouhal number

T Period

U Flow speed

U_m Amplitude of sinusoidal flow speed

U_r Reduced velocity, $U/f_n D$

λ Length scaling factor

ρ Water density

ν Kinematic viscosity coefficient

ζ Non-dimensional damping term, $B/(4\pi M f_n)$

4. PARAMETERS

4.1 Scaling

The following dimensionless parameters should be considered when choosing the scaling law in a VIV experiment to ensure geometrical, kinematic, and dynamic similarities.

- Geometry. The model- and full- scale structures must have the same shape. For example, the ratio D/L =constant should be maintained for a circular cylinder. This applies also to the elastic deformation of the structure.
- Structure stiffness. The model- and full-scale structures must have the same structure

 INTERNATIONAL TOWING TANK CONFERENCE	ITTC – Recommended Procedures and Guidelines	7.5-02 -07-03.10 Page 6 of 16	
	Guideline for VIV Testing	Effective Date 2021	Revision 01

stiffness in accordance with the Cauchy's similitude law, i.e., $\left(\frac{\rho U^2}{E}\right)_p = \left(\frac{\rho U^2}{E}\right)_m$

- Reduced velocity, $U_r = \frac{U}{f_n D} U_r = \frac{U}{f_n D}$.
- Non-dimensional response amplitude, $\frac{A}{D}$. For example, the non-dimensional cross-flow response is denoted as $\frac{A_{CF}}{D}$.
- Mass ratio, m' . For a circular cylinder, $m' = \frac{M}{\rho \frac{\pi}{4} D^2 L}$.
- Damping factor, ζ . For a single degree of freedom system with linear material damping, it is defined as $\zeta = \frac{B}{4\pi M f_n}$ $\zeta = \frac{C}{4\pi M f_n}$.
- Reynolds number, $Re = \frac{UD}{\nu}$.
- Froude number, $F_r = \frac{U}{\sqrt{gD}} = \frac{U}{(Lg)^{\frac{1}{2}}}$.

Note that the reduced velocity and the non-dimensional response amplitude are related to the kinematic similarity. The mass ratio, the damping factor, the Reynolds number, and the Froude number are related to the dynamic similarity.

The type of force to be considered depends on the importance of the actual force contribution. For 2D and 3D free-vibration tests, the model mass ratio should be kept the same as the full-scale one. In most cases, this requirement excludes free-vibration tests in wind tunnel for marine structures since the fluid densities for such structures are typically 1000 larger than the air density. For 2D and 3D free-vibration tests, the damping factor is also required to be the same in model and full scales.

The Reynolds number defines the ratio of the inertial force to the viscous force in the boundary layer of a bluff body. Since VIV depends on the boundary layer thickness, the response will

be Reynolds number dependent. For a deeply submerged body not influenced by surface waves, the VIV model test should ideally be scaled according to the Reynolds number. In practice, it is difficult to scale the kinematic viscosity coefficient, ν , in a model test. To keep the Reynolds number constant and to scale down the geometrical dimension (e.g., D and L), the speed, U , must be increased. When using Reynolds number scaling, it normally leads to large model structures and high flow speed which can be challenging with respect to the dimensional forces on the model and the test rig, the size of test facility and the cost.

For 3D tests, when the tension in the structure contributes significantly to the structure stiffness (geometrical stiffness) and when the tension varies along the structure due to gravity forces, Froude scaling is recommended. In general, Froude's scaling law can be used for determining the dimension of the model for most types of model tests, except tests in prototype scale.

If the Froude scaling law is found not necessary, one is free to deviate from it. For example, one could choose another scaling law for 2D tests of a submerged riser section or 3D tests of a submerged pipe where the tension is constant. The tension of a pipe will be constant for a horizontal pipe with uniform distributed weight or for a pipe which has a neutral weight in water.

One possibility is to scale the model test velocity, U_m , to the prototype velocity in a power of n , i.e., $U_m = U_p(\lambda)^n$, where λ is the scaling factor and U_p is the prototype velocity. Other physical parameters must then be derived using the length scale factor and the power factor n . For example, the period in the model becomes:

$$T_m = T_p \lambda^{-1-n} \quad (1)$$

	ITTC – Recommended Procedures and Guidelines	7.5-02 -07-03.10 Page 7 of 16	
	Guideline for VIV Testing	Effective Date 2021	Revision 01

When applying a selected scaling law, such as Froude’s similitude law, all relevant parameters of the tests must be scaled accordingly, such as the geometry of the full-scale design, the water flow, mass, and stiffness. For an elastic cylinder model, this implies that the axial-cross-section, torsion and bending stiffness must be correctly scaled. A cylinder with non-homogeneous cross sections can be made to meet this requirement, where a core part has the correctly scaled stiffness properties, and an outer layer has the correctly scaled outer dimensions without contribution to the stiffness. In some flexible riser systems, the frequencies of the VIV excitation force will be lower than the axial natural frequencies. The axial dynamics can then be neglected. A model with a higher axial stiffness than the scaled stiffness according to Froude’s scaling law can be acceptable. The same principle can be applied to the torsion stiffness if the torsion dynamics is found negligible.

4.2 Model geometry

A geometrically similar model of a full-scale design is constructed at a scale so that the tests can be performed according to the selected scaling law. The geometry model can be simplified, if there is minimal impact on the physical phenomenon to be measured, particularly the boundary layer of the flow.

Appendages such as strakes and fairings need to be included.

The diameter of the riser in 2D VIV tests is normally larger than that in 3D tests. Therefore, more details can be included in the 2D tests. The L/D ratio depends on the structure studied and the dimension of the test facility. For a free-spanning pipeline, it can be 50 to 200 and for a deep-water riser it can be greater than 1000.

Aspects of the preparing the model and the mooring system can be found in the ITTC Recommended Procedure for Floating Offshore Platform Experiments (7.5-02-07-03.1).

The surface roughness becomes important when the flow is in the critical Reynolds range. The critical Reynolds number range is influenced by the turbulence in water and the surface roughness. For a smooth cylinder, the typical critical Reynolds number range is approximately 2×10^5 to 10^6 .

In 2D tests, it is assumed that the flow conditions are constant over the length of the cylinder. End plates are used to ensure that there are no 3D effects on the two ends of the cylinder.

4.3 Suppression devices

The most popular suppression devices used by the industry are strakes and freely-rotating fairings. Figure 3 shows examples of models of strakes and fairings.

Strakes consist of helical elements that are wrapped around a cylinder. Most of the shedding will be at the edge of the helical elements. Consequently, the strake elements will take control over the shedding process and organize the vortex process in such a way that most of the vortex-induced forces will be suppressed and the VIV will be reduced. A disadvantage in using strakes is that the drag loads can be as large as the drag forces for a cylinder without strakes.

Fairings can be effective in suppressing VIV and in reducing drag for cylinders. For some fairing shapes, large lateral oscillations (galloping/fluttering) can be developed once the flow exceeds a certain critical speed. It has been shown that the onset of galloping is dependent on the rotational friction between the cylinder and the fairing. Care should therefore be taken to the friction in model tests involving fairings.

 ITTC INTERNATIONAL TOWING TANK CONFERENCE	ITTC – Recommended Procedures and Guidelines	7.5-02 -07-03.10 Page 8 of 16	
	Guideline for VIV Testing	Effective Date 2021	Revision 01

Friction coefficients can be calculated by the Coulomb damping model, which has proven to be a suitable model for fairing-riser friction (Lie et al., 2014). In this model, a decay test was performed to determine the friction coefficient, in which the fairing model was freely rotating in air around the riser model.

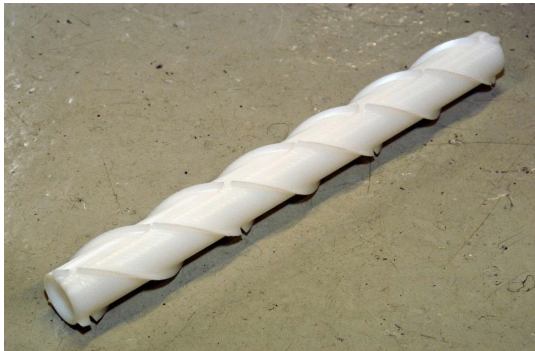

Figure 3. Examples of suppression device models. Upper: strakes (Trim et al., 2005), Lower: fairings (Braaten et al., 2008).

4.4 Marine growth

Marine growth increases the mass and the diameter of the pipe and increases the surface roughness. So, it should be considered in VIV studies. Since the use of organic materials is often not allowed in a laboratory, artificial marine growth must be modelled and manufactured, including both hard and soft marine growths. Soft marine growth can be modelled by using different types of fabrics/carpets. To simulate the hard-marine

growth in laboratory, sandpaper, coarse sand, and gravel of different sizes can be used.

4.5 Riser interaction

In deep water, the interaction between risers in an array is an issue of considerable concern.

The interaction of a riser array in current is a very complicated hydroelasticity problem. Due to the wake of an upstream riser, the mean flow velocity at a downstream riser will be less than the free stream velocity. Consequently, the mean drag will also be less for downstream risers compared to upstream risers. In addition, riser clashing may occur. Furthermore, the dynamic responses can be characterized by motions in different time scales. Long-periodic translations occur at the first mode and high-frequency VIV motions occur at much higher modes. The former response is denoted as wake induced oscillations (WIO).

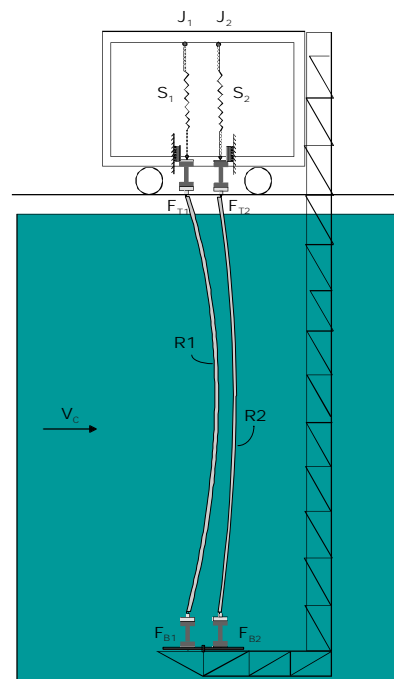



Figure 4. Example of a set-up for a riser interaction model test of two top-tensioned risers.

 ITTC INTERNATIONAL TOWING TANK CONFERENCE	ITTC – Recommended Procedures and Guidelines	7.5-02 -07-03.10 Page 9 of 16	
	Guideline for VIV Testing	Effective Date 2021	Revision 01

Corresponding studies of interaction between two cylinders can be referred to Sanaati and Kato (2014), Han et al (2018), Xu et al (2018a, 2018b, 2020a, 2020b), Huera-Huarte et al (2011, 2016), Wu et al (2020). Recently, researches concentrate more attentions on VIV and WIO of multi-risers, such as Wang et al (2019), Xu et al (2018c), Oviedo-Tolentino et al (2013). They found that interactions among multi-risers were more complicated than that of two risers, and it was unsuitable to predict VIV responses of multi-risers from vibration features of two risers.

Hydrodynamic interactions and clashing of two or more long risers can be studied by use of model tests. A typical set-up in a towing tank is shown in Figure 4 (Baarholm et al., 2007). Similar set-ups can also be done in a tank with current.

Aspects of the model set-up can be found in the ITTC Recommended Procedure for Floating Offshore Platform Experiments (7.5-02-07-03.1).

4.6 Environmental parameters

Current is typically the only environmental parameter in VIV tests. However, in the case of risers, the effect of wind and waves on platform's motion to which they are attached can significantly affect the VIV on them.

Ocean current velocity varies in both space and time. This gives a time varying profile. The current is typically described as a mean (constant) speed with time-varying velocity (turbulence).

For offshore structural design at a given location, the design current profiles are often obtained based upon field measurements of the current velocities at several current meter locations along a vertical line. The direction and time-varying velocities are normally neglected.

In VIV tests, the current can either be simulated by re-circulating water around the model or by towing the model using a carriage. In the former case, the current must be calibrated prior to the test. The current profile must be calibrated at the projected location of the test model. Uniform- or sheared- flow profiles can be generated. The profile and the turbulence intensity level should be documented. When using a carriage to tow the model, the carriage speed must be calibrated prior to VIV tests.

When the sheared flow needs to be modelled, the top and the bottom of the riser model are connected to a pretension-impose-device and the centre shaft of a tower through universal joints, respectively, maintaining a constant pretension. The riser model is driven to rotate in the tank by the tower and the relative sheared flow is produced by controlling the rotation velocity of the tower (Song et al., 2016). During the experiments, the flow velocity at the top of the riser model is the largest, and the velocity at the bottom is zero.

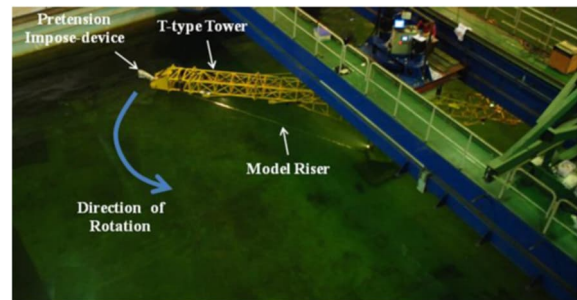



Figure 5. Example of an experimental setup for a flexible riser in a sheared flow.

When waves and vessel motions are present together with current, it is expected that waves and motions will generally reduce the VIV related responses compared to the pure current conditions.

Under the effects of wind, waves and currents, the floating platform will periodically oscillate in the water. Relative oscillations will

	ITTC – Recommended Procedures and Guidelines	7.5-02 -07-03.10 Page 10 of 16	
	Guideline for VIV Testing	Effective Date 2021	Revision 01

be generated between the flexible riser and the water in the middle part of the riser. Intermittent VIV responses and periodic VIV developing processes will occur in the oscillatory flow (Fu et al., 2013 and Fu et al., 2018), which are quite different from VIV responses in steady flows such as uniform flow, sheared flow and stepped flow.

For steel catenary riser (SCR) systems, the vessel (heave) motion may lead to an oscillatory flow at the lower part of riser, which may cause VIV. This phenomenon is often referred to as heave-induced VIV or parametrically excited vibration. The heave motion with comparatively large amplitude and high heave frequency can lead to the fluctuation of the pretension that will cause VIV (Wang and Wan, 2019) and the tension may be transformed into pressure at a certain part of the riser to produce dangerous dynamic stresses (Kuiper et al., 2008).

For the horizontal motion of a floating platform, the top-end sway motion will cause intermittent VIV responses of flexible risers, which are more complicated than VIV responses in steady flows. Wang et al. (2016) found that platform-induced VIV presents strong time consistency in both vibration amplitude and frequency responses. Fu et al. (2017) also investigated VIV responses of a flexible riser under different combinations of top-end motions. VIV characteristics will become much more complicated due to the floating platform motions and the oncoming flow.

Forces on a cylinder in a basin of finite dimension are different from those in infinite fluid. This is denoted as the blockage effect, which is caused by the presence of walls and the free surface confinement. Zdravkovich (2003) states that no correction of force is needed when the blocking ratio $D/B < 0.1$ if $Re > 350$. At lower Reynolds numbers, the blockage may be important even for lower D/B ratios.

4.7 Internal flows

In addition to the external excitations, the effect of internal flow should be considered in VIV analysis due to the large aspect ratio and flexibility of flexible risers (Duanmu and Wan, 2018; Wu and Lou, 1991; Lee et al., 1995; Guo and Lou, 2008). The centrifugal and Coriolis forces are generated by the relative movement between the internal flow and the riser, which influence VIV responses of flexible risers. Due to the complicated components of the internal flow consisting of water, oil and gas, the flow velocity and volume ratio among different phases will cause the fluctuation in mass and pressure to increase the complexity of VIV responses (Montoya-Hernández et al., 2014)

5. DESCRIPTION OF THE TEST PROCEDURE

5.1 Model test objective

Before planning the tests, a statement of the test objectives and a test matrix are required. Judicious use of computations can help to reduce the extent of the test matrix.

5.2 Test rig

In general, the natural frequencies of the test rig should not approach to the VIV response frequencies. The natural frequencies of the test rig should be significantly greater (at least 5 times) than the highest VIV response frequency.

For elastically mounted rigid-cylinder tests, the test rig should be designed such that only the responses in the desired degree of freedom (DOF) are obtained. For example, if only the cross-flow response is wanted, the responses in the other 5 DOFs should be suppressed.

VIV is characterized by self-excited and self-limited loading processes. Any damping in

	ITTC – Recommended Procedures and Guidelines	7.5-02 -07-03.10 Page 11 of 16	
	Guideline for VIV Testing	Effective Date 2021	Revision 01

the dynamic system will reduce the responses. For 2D or 3D free-vibration tests, it implies that the test rig should have low damping. The damping, ζ , should preferably be less than 1% of the critical damping.

5.3 Measurement system and calibration

A 2D model test usually requires a relative small amount of instrumentation for the following measurements:

1. Measurement of cylinder motions. This can be obtained by use of:
 - a) an optical tracking system; or
 - b) a system consisting of a linear spring and an axial force transducer that are coupled in series. This system should be coupled between the cylinder and the test rig in the direction of the desired direction (e.g. CF direction) and should be calibrated for displacement measurements; or
 - c) other motion measurement systems.
2. Accelerations of the cylinder motion. These signals can be double integrated to obtain the cylinder motions.
3. Measurements of the forces acting on the cylinder. Force transducers, fixed to the cylinder ends, are typically used.
4. Tensions in springs or mooring lines by means of force transducers.

Option 1 or 2 will be typically required. If the cylinder is under forced motion, Option 3 is also required. If the cylinder is free to move, Option 3 is then optional.

A 3D model test often requires much more comprehensive instrumentation. Bi-axial accelerometers and/or strain sensors are normally used to measure the flexible cylinder responses. Instrumentation cables should not be placed outside the model if they may affect the hydrodynamic loading. The strain measurements can be done using traditional electronic strain sensors or using optical fibre

sensors such as Fibre Bragg Grating (FBG). The optical fibre sensors are attractive for model tests, especially when many sensors are required and there is limited space inside the cylinder model to host many electrical cables.

It is recommended to measure the noise (vibrations) of the test rig. This can be done by using three-component accelerometers.

All instrumentation should be in good order and calibrated. The locations and the orientations of all instrumentation should be documented. Further aspects can be found in ITTC Recommended Procedure for Floating Offshore Platform Experiments (7.5-02-07-03.1).

5.4 Test procedure and data acquisition

5.4.1 Pre-test considerations

After the model and instrumentation installation and prior to the experiment commencement, the performance and the sign convention of all transducers and gauges should be confirmed by applying a known load or displacement. The process should be recorded through the data acquisition and stored for quality assurance purposes. The measured results should be compared to the applied quantities. This will indicate whether the transducers/gauges are functioning according to the calibration and conforming to the defined sign conventions. Adjustments can be made to the non-conforming devices, prior to testing, or corrections can be applied during the data processing.

Prior to running a VIV test, a data acquisition should be done in calm water using all measuring channels. This will provide a record of “zero” levels for all transducers before conducting experiments. These records are useful in identifying electronic drift, later in the experiments. They also serve as an additional

	ITTC – Recommended Procedures and Guidelines	7.5-02 -07-03.10 Page 12 of 16	
	Guideline for VIV Testing	Effective Date 2021	Revision 01

transducer check. Additional calm water runs can be acquired throughout the experiments.

5.4.2 Test procedure

When the test program commences, data acquisition for each run should start from calm water and end in calm water conditions, when this is easily achieved. This will serve as an additional check on the performance of instrumentation and on zero drift.

5.4.3 Measured quantities

Once the model is instrumented, calibrated, and in position, the test program can be carried out. The data should be collected digitally whenever possible. The sample rate should be high enough to capture the physical phenomenon being measured. The sample rate must be at least twice the highest frequency of interest. The simple rules below can be helpful when selecting sample rates.

A cross-flow peak response frequency can be approximated by the Strouhal frequency given as $f_{St} = S_t U/D$. The in-line peak frequency is often found to be about twice the CF peak response frequency. Higher-order responses may be observed in both *IL* and *CF* directions, such as $3f_{St}$, $4f_{St}$ and $5f_{St}$.

For free oscillation 2D experiments, the tests are typically conducted in the range of reduced velocities where large responses are expected. A typical reduced velocity range for a cylinder with low structural damping and a low mass ratio is 4 ~ 20 (see Figure 2a). Note that the range depends on the mass ratio of the model and the structural damping. A cylinder with low mass ratio will be more affected by the added mass. Therefore, a low mass ratio cylinder will have large responses in a larger reduced velocity range than a cylinder with high mass ratio. Low structural damping will also lead to large responses in a larger reduced velocity range

compared to a cylinder with greater structural damping.

In general, the data should be low-pass or band-pass hardware filtered. The cut-off frequencies should not eliminate the desired data. The sample rate should be consistent with the hardware filters to avoid step functions in the data.

Furthermore, the test runs must be long enough to collect a statistically valid sample. This length depends on the nature of the response. If the response appears to be stable and harmonic, oscillations in the order of 10-40 should be sufficient to determine a statistically valid sample. If the response appears to be irregular or unstable, more oscillations, maybe up to 100, are needed. If different sampling rates are used, care should be taken to ensure synchronization of the measured signals.

5.4.4 Data analysis

For engineering applications, results can be presented in dimensional form. To check results and compare with databases, responses should be presented in a non-dimensional form. Linear motions may be divided by a characteristic length, such as the outer diameter, in the case of a cylinder.

Mean drag and lift coefficients C_D and C_L can be nondimensionalized by the characteristic length, L , and diameter, D , as follows:

$$C_D = \frac{\bar{F}_D}{\frac{1}{2}\rho D U^2 L} \quad (2)$$

$$C_L = \frac{\bar{F}_L}{\frac{1}{2}\rho D U^2 L} \quad (3)$$

For cylinders with strakes, D normally refers to the diameter without the strakes. For cylinders with fairings, D usually refers to the

	ITTC – Recommended Procedures and Guidelines	7.5-02 -07-03.10 Page 13 of 16	
	Guideline for VIV Testing	Effective Date 2021	Revision 01

outer diameter of the fairing cross section. Note that $\overline{F_L}$ is typically zero for circular cylinders.

Results should be presented in plots and in tabular form. Tabular data should include statistical results such as maximum, minimum, mean, standard deviation, and significant values for each channel and for each run.

Prior to the data analysis, the data should be selected for a time window where transient responses in the start and end of the time series are omitted. For a decay test, the end of the time window, can be defined as the instant in the time series when the response has been sufficiently damped out.

It can be difficult to determine the amplitude of a VIV response. In some situations, the response can be almost sinusoidal and in other cases it can appear more irregular. The most robust way of presenting the results is to compute the standard deviation of the response.

Some studies focus on the largest amplitudes. The average of the largest 10 percent of the amplitudes can be used.

More aspects on the procedures to obtain the response characteristics can be found in ITTC Procedure 7.5-02-07-03.2 “Analysis Procedure for Model Tests in Regular Wave”.

If VIV displacements are computed by double integration of acceleration signals, the acceleration signals should normally be high-pass filtered with a cut-off frequency that should be a fraction of the Strouhal frequency, e.g. $1/2 f_{St}$ or $1/3 f_{St}$.

5.4.5 Decay and pluck tests in air

For 2D or 3D free-vibration tests, the damping caused by the test rig and/or deformations in the test cylinder model (flexible) should be documented. This damping is often

denoted as material damping. This could be done by a pluck test and/or by a decay test in air.

5.4.6 Decay and pluck tests in water

If possible, decay tests and/or pluck tests should be done also in water for 2D free-vibration tests to document the damping of the test set-up. The test should be done without the test cylinder.

5.4.7 Pluck test on test rig

The natural frequency of the test rig can be found by pluck tests on the test rig. The pluck test can be done with a hammer or a similar tool to excite the test rig in different directions. The response signals should be analysed with spectral analysis tools.

6. UNCERTAINTY ANALYSIS

Uncertainty analysis should be performed in accordance with ‘Uncertainty Analysis in EFD, Uncertainty Assessment Methodology’ as described in QM 4.9-03-01-01 and ‘Uncertainty Analysis in EFD, Guidelines for Uncertainty Assessment’ as described in QM 4.9-03-01-02. Additionally, an example on ‘Uncertainty Analysis, Example for Resistance Test’ is provided in QM 7.5-02-02-02.

7. REFERENCES

- Baarholm, R., Kristiansen T., Lie, H., 2007, "Interaction and Clashing between Bare or Straked Risers, Analyses of Experimental Results", Proceedings of 26th International Conference on Offshore Mechanics and Arctic Engineering, San Diego, California.
- Blevins, R.D., 1990, Flow-Induced Vibration, Van Nostran Reinhold, New York.

	ITTC – Recommended Procedures and Guidelines	7.5-02 -07-03.10 Page 14 of 16	
	Guideline for VIV Testing	Effective Date 2021	Revision 01

- Braaten, H., Lie, H., Skaugset, K., 2008, "Higher order modal response of riser fairings", Proceedings of 27th International Conference on Offshore Mechanics and Arctic Engineering, Estoril, Portugal.
- Duanmu Y, Zou L, Wan, DC, 2018, "Numerical analysis of multi-modal vibrations of a vertical riser in step currents", Ocean Engineering, v. 152, pp. 428-442.
- Fu, S.X., Wang, J.G., Baarholm, R., et al., 2013. "VIV of Flexible Cylinder in Oscillatory Flow", International Conference on Offshore Mechanics and Arctic Engineering -OMAE2013, Nantes, France, OMAE2013-10348.
- Fu, B.W., Zou, L., Wan, D.C., 2017, "Numerical Study on the Effect of Current Profiles on Vortex-Induced Vibrations in a Top-Tension Riser", Journal of Marine Science and Application, 16: 473-479.
- Fu, B.W., Zou, L., Wan, D.C., 2018, "Numerical study of vortex-induced vibrations of a flexible cylinder in an oscillatory flow", Journal of Fluids and Structures, v. 77, pp. 170-181.
- Govardhan, R. and Williamson, C., 2000, "Modes of Vortex Formation and Frequency Response of a Freely Vibrating Cylinder", Journal of Fluid Mechanics, Vol. 420, pp. 85-130.
- Guo, H., Lou, M., 2008, "Effect of internal flow on vortex-induced vibration of risers", Journal of Fluids and Structures, Vol. 24, pp. 496-504.
- Han, Q., Ma, Y., Xu, W., Zhang S., 2018. "An experimental study on the hydrodynamic features of two side-by-side flexible cylinders undergoing flow-induced vibrations in a uniform flow", Marine Structures, Vol. 61, pp. 326-342.
- Huera-Huarte, F.J., Gharib, M., 2011. "Flow-induced vibrations of a side-by-side arrangement of two flexible circular cylinders", Journal of Fluids and Structures, Vol. 27, pp. 354-366.
- Huera-Huarte, F.J., Bangash, Z.A., González, L.M, 2016. "Multi-mode vortex and wake-induced vibrations of a flexible cylinder in tandem arrangement". Journal of Fluids and Structures, Vol. 66, pp. 571-588.
- Jauvtis, N., and Williamson, C., 2004, "The Effect of 2 Degrees of Freedom on VIV at Low Mass and Damping", Journal of Fluid Mechanics, Vol. 509, pp. 23-62.
- Kuiper, G.L., Brugmans, J., Metrikine, A.V., 2008, "Destabilization of deep-water risers by a heaving platform" Journal of Sound & Vibration, 310, 541-557.
- Lee, U., Park, C., Hong, S.C., 1995, "The dynamics of a piping system with internal unsteady flow", Journal of Sound & Vibration, 180 (2): 297-311.
- Lie, H., Yin, D., Liapis, S., 2014, "On the Torsional Friction of Freely Rotating Short Fairing", Proceedings of 33rd International Conference on Ocean, Offshore Mechanics and Arctic Engineering, OMAE2014-24591, June 8-13, 2014 San Francisco, USA.
- Liu, G.J., Li, H.Y., Qiu, Z.Z., Leng, D.X., Li, Z.X., Li, W.H., 2020. "A mini review of recent progress on vortex-induced vibrations of marine risers", Ocean Engineering, Vol. 195, 106704.
- Montoya-Hernández, D.J., Vázquez-Hernández, A.O., Cuamatzi, R., Hernandez, M.A., 2014, "Natural frequency analysis of a marine riser considering multiphase internal flow behavior", Ocean Engineering, Vol. 92, pp. 103-113.

 INTERNATIONAL TOWING TANK CONFERENCE	ITTC – Recommended Procedures and Guidelines	7.5-02 -07-03.10 Page 15 of 16	
	Guideline for VIV Testing	Effective Date 2021	Revision 01

- Oviedo-Tolentino, F., Romero-Méndez, R., Hernández-Guerrero, A., Pérez-Gutiérrez, F.G., 2013. “Vortex-induced vibration of a collinear array of bottom fixed flexible cylinders”. Journal of Fluids and Structures, Vol. 39, pp. 1-14.
- Sanaati, B., Kato, N., 2014. “A study on the proximity interference and synchronization between two side-by-side flexible cylinders”, Ocean Engineering, 2014, Vol. 85, pp. 65-79.
- Sarpkaya, T., 2004, "A Critical Review of the Intrinsic Nature of Vortex-Induced Vibrations", Journal of Fluid and Structures, Vol. 19, No. 4, pp. 389-447.
- Song L., Fu S., Dai S., Zhang M., and Chen Y., 2016, "Distribution of drag force coefficient along a flexible riser undergoing VIV in sheared flow", Ocean Engineering, Vol. 126, pp. 1-11.
- Sumer, B.M., Fredsøe, J., 2006, Hydrodynamics around Cylindrical Structures, World Scientific, Singapore.
- Trim, A.D., Braaten, H., Lie, H., Tognarelli, M. A., 2005, "Experimental Investigation of Vortex-Induced Vibration of Long Marine Risers", Journal of Fluids and Structures, Vol. 21, pp. 335-361.
- Wan, D.C., and Duan, M.Y., 2017, “A Recent Review of Numerical Studies on Vortex Induced Vibrations of Long Slender Flexible Risers in Deep Sea”, Chinese Quarterly of Mechanics, Vol. 28, No. 2, pp. 179-196.
- Wang, E., Xu, W., Yu, Y., Zhou, L., Incecik, A., 2019. “Flow-induced vibrations of three and four long flexible cylinders in tandem arrangement: An experimental study”, Ocean Engineering, Vol. 178, pp. 170-184.
- Wang, J., Xiang, S., Fu, S., Cao, P., Yang, J., He, J., 2016, “Experimental investigation on the dynamic responses of a free-hanging water intake riser under vessel motion”, Marine Structures, vol. 50, pp. 1–19.
- Wang, Z., Wan, D.C., 2019. “Numerical simulations of vortex-induced vibrations of flexible cylinder with varying tensions based on CFD method”, Chinese Journal of Hydrodynamics, 34(2), pp. 201–209.
- Willden, R., 2003, “Numerical Prediction of the VIV of Marine Risers”, Ph.D. Thesis, Imperial College.
- Wu, L., Zhao, W., Wan, D.C., 2020. “Numerical simulations on vortex-induced vibrations (VIV) of two tandem risers with different submerged lengths”. The Ocean Engineering, Vol. 38(3), pp. 52-61.
- Wu, M., Lou, J.Y., 1991, “Effects of rigidity and internal flow on marine riser dynamics”, Apply Ocean Research, v. 13 (5), pp. 235–244.
- Xu, W., Ma, Y., Cheng, A., Yuan H., 2018a. “Experimental investigation on multi-mode flow-induced vibrations of two long flexible cylinders in a tandem arrangement”, International Journal of Mechanical Sciences, Vol. 135, pp. 261-278.
- Xu, W., Cheng, A., Ma, Y., Gao, X., 2018b. “Multi-mode flow-induced vibrations of two side-by-side slender flexible cylinders in a uniform flow”, Marine Structures, Vol. 57, pp. 219-236.
- Xu, W., Zhang, S., Liu, B., Bai, Y., 2018. “An experimental study on flow-induced vibration of three and four side-by-side long flexible cylinders”, Ocean Engineering, Vol. 169, pp. 492-510.
- Xu, W., Qin, W., Yu, Y., 2020a. “Flow-induced vibration of two identical long flexible cylinders in a staggered arrangement”,

	ITTC – Recommended Procedures and Guidelines	7.5-02 -07-03.10 Page 16 of 16	
	Guideline for VIV Testing	Effective Date 2021	Revision 01

International Journal of Mechanical Sciences, Vol. 180, 105637.

Zdravkovich, M.M., 2003, Flow around Circular Cylinders, vol. 2: Applications. London, UK, Oxford University Press.

Xu, W., Zhang, Q., Lai, J., Wang, Q., Yu, Y., 2020b. “Flow-induced vibration of two staggered flexible cylinders with unequal diameters”, Ocean Engineering, Vol. 211, 107523.